

EMX-H310P

Intel® 8/9th Generation Core™ Processor Mini ITX
Motherboard With Intel® H310 Chipset

User's Manual

2nd Ed – 23 March 2021

FCC Statement



THIS DEVICE COMPLIES WITH PART 15 FCC RULES. OPERATION IS SUBJECT TO THE FOLLOWING TWO CONDITIONS:

- (1) THIS DEVICE MAY NOT CAUSE HARMFUL INTERFERENCE.
- (2) THIS DEVICE MUST ACCEPT ANY INTERFERENCE RECEIVED INCLUDING INTERFERENCE THAT MAY CAUSE UNDESIRE OPERATION.

THIS EQUIPMENT HAS BEEN TESTED AND FOUND TO COMPLY WITH THE LIMITS FOR A CLASS "A" DIGITAL DEVICE, PURSUANT TO PART 15 OF THE FCC RULES.

THESE LIMITS ARE DESIGNED TO PROVIDE REASONABLE PROTECTION AGAINST HARMFUL INTERFERENCE WHEN THE EQUIPMENT IS OPERATED IN A COMMERCIAL ENVIRONMENT. THIS EQUIPMENT GENERATES, USES, AND CAN RADIATE RADIO FREQUENCY ENERGY AND, IF NOT INSTALLED AND USED IN ACCORDANCE WITH THE INSTRUCTION MANUAL, MAY CAUSE HARMFUL INTERFERENCE TO RADIO COMMUNICATIONS.

OPERATION OF THIS EQUIPMENT IN A RESIDENTIAL AREA IS LIKELY TO CAUSE HARMFUL INTERFERENCE IN WHICH CASE THE USER WILL BE REQUIRED TO CORRECT THE INTERFERENCE AT HIS OWN EXPENSE.

Notice

This guide is designed for experienced users to setup the system within the shortest time. For detailed information, please always refer to the electronic user's manual.

Copyright Notice

Copyright © 2021 Avalue Technology Inc., ALL RIGHTS RESERVED.

No part of this document may be reproduced, copied, translated, or transmitted in any form or by any means, electronic or mechanical, for any purpose, without the prior written permission of the original manufacturer.

Trademark Acknowledgement

Brand and product names are trademarks or registered trademarks of their respective owners.

Disclaimer

Avalue Technology Inc. reserves the right to make changes, without notice, to any product, including circuits and/or software described or contained in this manual in order to improve design and/or performance. Avalue Technology assumes no responsibility or liability for the use of the described product(s), conveys no license or title under any patent, copyright, or masks work rights to these products, and makes no representations or warranties that

these products are free from patent, copyright, or mask work right infringement, unless otherwise specified. Applications that are described in this manual are for illustration purposes only. Avalue Technology Inc. makes no representation or warranty that such application will be suitable for the specified use without further testing or modification.

Life Support Policy

Avalue Technology's PRODUCTS ARE NOT FOR USE AS CRITICAL COMPONENTS IN LIFE SUPPORT DEVICES OR SYSTEMS WITHOUT THE PRIOR WRITTEN APPROVAL OF Avalue Technology Inc.

As used herein:

1. Life support devices or systems are devices or systems which, (a) are intended for surgical implant into body, or (b) support or sustain life and whose failure to perform, when properly used in accordance with instructions for use provided in the labeling, can be reasonably expected to result in significant injury to the user.
2. A critical component is any component of a life support device or system whose failure to perform can be reasonably expected to cause the failure of the life support device or system, or to affect its safety or effectiveness.

A Message to the Customer

Avalue Customer Services

Each and every Avalue's product is built to the most exacting specifications to ensure reliable performance in the harsh and demanding conditions typical of industrial environments. Whether your new Avalue device is destined for the laboratory or the factory floor, you can be assured that your product will provide the reliability and ease of operation for which the name Avalue has come to be known.

Your satisfaction is our primary concern. Here is a guide to Avalue's customer services. To ensure you get the full benefit of our services, please follow the instructions below carefully.

Technical Support

We want you to get the maximum performance from your products. So if you run into technical difficulties, we are here to help. For the most frequently asked questions, you can easily find answers in your product documentation. These answers are normally a lot more detailed than the ones we can give over the phone. So please consult the user's manual first.

To receive the latest version of the user's manual; please visit our Web site at:

<http://www.avalue.com.tw/>

EMX-H310P User's Manual

Product Warranty

Avalue warrants to you, the original purchaser, that each of its products will be free from defects in materials and workmanship for two years from the date of purchase.

This warranty does not apply to any products which have been repaired or altered by persons other than repair personnel authorized by Avalue, or which have been subject to misuse, abuse, accident or improper installation. Avalue assumes no liability under the terms of this warranty as a consequence of such events. Because of Avalue's high quality-control standards and rigorous testing, most of our customers never need to use our repair service. If any of Avalue's products is defective, it will be repaired or replaced at no charge during the warranty period. For out-of-warranty repairs, you will be billed according to the cost of replacement materials, service time, and freight. Please consult your dealer for more details. If you think you have a defective product, follow these steps:

1. Collect all the information about the problem encountered. (For example, CPU type and speed, Avalue's products model name, hardware & BIOS revision number, other hardware and software used, etc.) Note anything abnormal and list any on-screen messages you get when the problem occurs.
2. Call your dealer and describe the problem. Please have your manual, product, and any helpful information available.
3. If your product is diagnosed as defective, obtain an RMA (return material authorization) number from your dealer. This allows us to process your good return more quickly.
4. Carefully pack the defective product, a complete Repair and Replacement Order Card and a photocopy proof of purchase date (such as your sales receipt) in a shippable container. A product returned without proof of the purchase date is not eligible for warranty service.
5. Write the RMA number visibly on the outside of the package and ship it prepaid to your dealer.

Content

1. Getting Started	8
1.1 Safety Precautions.....	8
1.2 Packing List.....	8
1.3 Document Amendment History	9
1.4 Manual Objectives.....	10
1.5 System Specifications	11
1.6 Architecture Overview—Block Diagram	14
2. Hardware Configuration	15
2.1 Product Overview.....	16
2.2 Jumper and Connector List.....	17
2.3 Setting Jumpers & Connectors	19
2.3.1 Serial port 1 pin9 signal select (JRI1)	19
2.3.2 Serial port 2 pin9 signal select (JRI2)	19
2.3.3 BIOS ME function configuration (JME1)	20
2.3.4 Clear CMOS (JCMOS1).....	20
2.3.5 AT/ATX Power Mode Select (JSATX1).....	21
2.3.6 General purpose I/O connector (DIO1).....	21
2.3.7 ATX Power connector (ATXPWR2)	22
2.3.8 USB connector (JUSBH1).....	22
2.3.9 LPC connector (JLPC1)	23
2.3.10 Miscellaneous setting connector (SPI1).....	23
2.3.11 Speaker connector (SPK1).....	24
2.3.12 LCD Inverter connector (JBKL1)	24
2.3.13 Front Panel connector (JFP1)	25
2.3.14 CPU fan connector (CPUFAN1).....	25
2.3.15 System fan connector (SYSFAN1).....	26
2.3.16 ATX Power connector (ATXPWR1).....	26
2.3.17 Serial port connector (COM1).....	27
2.3.18 Serial port connector (COM2).....	27
2.3.19 J1RS1 connector (J1RS1).....	28
2.3.20 J1RS2 connector (J1RS2).....	28
2.3.21 Auxiliary Panel connector (JAUXP1).....	29
2.3.22 eDP-Panel connector (EDP 1).....	29
2.3.23 LVDS connector (LVDS1).....	30
2.3.24 Serial port connector (4COM1).....	31
2.3.25 Audio connector (FAUD1)	32

EMX-H310P User's Manual

3.BIOS Setup	33
3.1 Introduction	34
3.2 Starting Setup	34
3.3 Using Setup	35
3.4 Getting Help	36
3.5 In Case of Problems	36
3.6 BIOS setup	37
3.6.1 Main Menu	37
3.6.1.1 System Language	38
3.6.1.2 System Date	38
3.6.1.3 System Time	38
3.6.2 Advanced Menu	38
3.6.2.1 CPU Configuration	39
3.6.2.1.1 CPU - Power Management Control	40
3.6.2.2 PCH-FW Configuration	41
3.6.2.2.1 Firmware Update Configuration	41
3.6.2.3 Trusted Computing	42
3.6.2.4 ACPI Settings	42
3.6.2.5 Super IO Configuration	43
3.6.2.5.1 Serial Port 1 Configuration	44
3.6.2.5.2 Serial Port 2 Configuration	44
3.6.2.5.3 Serial Port 3 Configuration	45
3.6.2.5.4 Serial Port 4 Configuration	45
3.6.2.5.5 Serial Port 5 Configuration	46
3.6.2.5.6 Serial Port 6 Configuration	46
3.6.2.6 NCT6106D H/W Monitor	47
3.6.2.6.1 Smart Fan Configuration	47
3.6.2.7 S5 RTC Wake Settings	49
3.6.2.8 Serial Port Console Redirection	49
3.6.2.9 USB Configuration	50
3.6.2.10 Network Stack Configuration	51
3.6.3 Chipset	52
3.6.3.1 System Agent (SA) Configuration	52
3.6.3.1.1 Memory Configuration	53
3.6.3.1.2 Graphics Configuration	54
3.6.3.1.3 DMI/OPI Configuration	54
3.6.3.1.4 PEG Port Configuration	55
3.6.3.1.4.1 PEG Port Feature Configuration	56
3.6.3.2 PCH-IO Configuration	56
3.6.3.2.1 PCI Express Configuration	57

3.6.3.2.1.1 PCI Express Root Port 5	57
3.6.3.2.1.2 Intel I211/I210 LAN Chip (PCI-E Port 6).....	58
3.6.3.2.1.3 M.2 KeyE (PCI-E Port 7~8)	59
3.6.3.2.1.4 Intel I211/I210 LAN Chip (PCI-E Port 11).....	60
3.6.3.2.1.5 Intel I211/I210 LAN Chip (PCI-E Port 12).....	61
3.6.3.2.2 SATA And RST Configuration	62
3.6.3.2.3 HD Audio Configuration	63
3.6.3.3 Board Configuration.....	63
3.6.4 Security.....	65
3.6.4.1 Secure Boot	65
3.6.4.1.1 Restore Factory Keys	66
3.6.4.1.2 Key Management.....	67
3.6.5 Boot	67
3.6.6 Save & Exit.....	68
3.6.6.1 Save Changes and Reset.....	68
3.6.6.2 Discard Changes and Reset.....	69
3.6.6.3 Restore Defaults	69
3.6.6.4 Launch EFI Shell from filesystem device	69
4. Drivers Installation.....	70
4.1 Install Chipset Driver	71
4.2 Install VGA Driver.....	72
4.3 Install ME Driver	74
4.4 Install Audio Driver	75
4.5 Install LAN Driver	76
4.6 Install RST Driver	78
5. Mechanical Drawing	80

1. Getting Started

1.1 Safety Precautions

Warning!



Always completely disconnect the power cord from your chassis whenever you work with the hardware. Do not make connections while the power is on. Sensitive electronic components can be damaged by sudden power surges. Only experienced electronics personnel should open the PC chassis.

Caution!



Always ground yourself to remove any static charge before touching the CPU card. Modern electronic devices are very sensitive to static electric charges. As a safety precaution, use a grounding wrist strap at all times. Place all electronic components in a static-dissipative surface or static-shielded bag when they are not in the chassis.

1.2 Packing List

Before you begin installing your single board, please make sure that the following materials have been shipped:

- 1 x EMX-H310P motherboard
- 2 x SATA cables
- 1 x Copper stud for M.2
- 1 x I/O Shield



If any of the above items is damaged or missing, contact your retailer.

1.3 Document Amendment History

Revision	Date	By	Comment
1 st	November 2020	Avalue	Initial Release
2 nd	March 2021	Avalue	Update Setting Jumpers & Connectors

1.4 Manual Objectives

This manual describes in details Avalue Technology EMX-H310P Single Board.

We have tried to include as much information as possible but we have not duplicated information that is provided in the standard IBM Technical References, unless it proved to be necessary to aid in the understanding of this board.

We strongly recommend that you study this manual carefully before attempting to set up EMX-H310P or change the standard configurations. Whilst all the necessary information is available in this manual we would recommend that unless you are confident, you contact your supplier for guidance.

Please be aware that it is possible to create configurations within the CMOS RAM that make booting impossible. If this should happen, clear the CMOS settings, (see the description of the Jumper Settings for details).

If you have any suggestions or find any errors regarding this manual and want to inform us of these, please contact our Customer Service department with the relevant details.

1.5 System Specifications

System	
CPU	Intel® 8th Gen Supports LGA 1151 CPU Up to 95W Max Intel® 9th Gen Supports 4 core & 6 core CPU (TDP: 95W), 8 core CPU, only support CPU TDP up to 35W Max.
BIOS	AMI uEFI BIOS, 256Mbit SPI Flash ROM
System Chipset	Intel® H310 Express Chipset
I/O Chip	Nuvoton® NCT6106D
System Memory	Two 260-pin DDR4 2400/2666MHz SO-DIMM socket, supports up to 64GB Max
Watchdog Timer	H/W Reset, 5~255 seconds/5~255 minutes
H/W Status Monitor	Monitoring CPU & System Temperature and Voltage
Expansion Slot	
PCIe	1 x PCI-e x16 1 x M.2 (3042/2242/2260/2280) B-Key, support WWAN+GNSS with SIM card slot & SSD (SATA) 1 x M.2 (2230) E-Key, support WiFi module
Storage	
SATA	3 x SATA III
Edge I/O	
LAN	1 x Intel® I219LM Gigabit Ethernet PHY 3 x Intel® I210AT PCI-e Gigabit Ethernet
USB 2.0	2 x USB 2.0
USB 3.1	6 x USB 3.1 Gen 1
DP	1 x DP++
HDMI	1 x HDMI
VGA	1 x VGA
Onboard I/O	
COM	COM 1~2: Support RS232/422/485 selected by BIOS selection 2 x 2 x 3 pin, pitch 2.00mm connector for COM 1~2 support RS232 with Pin 9,+5V/+12V/RI by jumper 2 x 2 x 3 pin, pitch 2.00mm connector for COM 2 support RS422/485 connector, Pin 5 with +5V 2 x 2 x 5 pin, pitch 2.00mm connector for COM1~2 support RS-232 connector COM 3~6 1 x 2 x 20 pin, pitch 2.00mm connector for COM 3~6 support RS-232 connector
USB 2.0	1 x 2 x 5 pin pitch 2.54mm connector for 2 x USB 2.0

EMX-H310P User's Manual

GPIO	1 x 2 x 10 pin, pitch 2.00mm connector for GPIO: 16 bits & +5V _S Level SMBus
CPU/System FAN	1 x 1 x 4 pin, pitch 2.54mm CPU fan connector with smart fan function supported 1 x 1 x 4 pin, pitch 2.54mm System fan connector with smart fan function supported
Buzzer	1 x Onboard buzzer
Front Panel	1 x 2 x 5 pin, pitch 2.54mm connector for front panel
RTC Battery	1 x 2 Pin Pitch 1.25mm Vertical type battery connector
AT/ATX Selector	1 x 1 x 3 pin pitch 2.00mm connector for AT/ATX jumper 1 x 2 x 10 pin ATX power connector 1 x 2 x 2 pin ATX 12V power connector
Clear CMOS	1 x 1 x 3pin, pitch 2.54mm connector for COMS Clear
LVDS	1 x 2 x 20 pin, pitch 1.25mm connector for LVDS (Default)
LCD Inverter	1 x 1 x 5 pin, pitch 2.00mm Wafer connector for LCD inverter backlight connector (5V/12V)
LPC	1 x 2 x 5 pin, pitch 2.0mm connector for LPC
BIOS SPI	1 x 2 x 4 pin, pitch 2.00mm connector for BIOS SPI
Audio	1 x 2 x 5 pin, pitch 2.54mm connector for front Audio
Activity Indicator LED	1 x 1 x 5 pin, pitch 2.00mm Wafer connector for LCD inverter backlight connector (5V/12V)
LPC	1 x 2 x 5 pin, pitch 2.0mm connector for LPC
BIOS SPI	1 x 2 x 4 pin, pitch 2.00mm connector for BIOS SPI
Audio	1 x 2 x 5 pin, pitch 2.54mm connector for front Audio
Amp Connector	1 x 4 pin, pitch wafer 2.00mm connector for 3W x 2 Speaker
Display	
Graphic Chipset	Intel® 8/9th Generation CPU integrated
Spec. & Resolution	VGA: 2048 x1536 @ 50 Hz DP++: 4096x2160@30Hz HDMI: 4096x2160@30Hz Dual channel 18/24-bits LVDS (Chrontel CH7511B eDP to LVDS) 1 x 2 x 15 pin, pitch 1.25mm connector for eDP
Multiple Display	Dual Display
Audio	
Audio Codec	Realtek ALC662 HD Audio Decoding Controller
Amplifier	ALC105 4Ω/3W per channel Amplifier
Ethernet	
LAN Chipset	1 x Intel® I219LM Gigabit Ethernet PHY 3 x Intel® I210AT PCI-e Gigabit Ethernet
LAN Spec.	10/100/1000 Base-Tx GbE compatible
Mechanical & Environmental Specification	
Power	+12V / +5V / 5V _{SB} /+3.3V / -12V

Requirement	
ACPI	Single power ATX Support S0, S3, S4, S5
Power Mode	AT/ATX mode
Operating Temp.	0°C ~ 60°C with 0.2m/s air flow
Storage Temp.	-40°C ~ 75°C (-40°F ~ 167°F)
Operating Humidity	40°C @ 95% Relative Humidity, Non-condensing
Size (L x W)	6.7" x 6.7" (170mm x 170mm)
Weight	0.40kg



Note: Specifications are subject to change without notice.

User condition suggestion:

- Other

Ethernet LED Indicator



1.6 Architecture Overview—Block Diagram

The following block diagram shows the architecture and main components of EMX-H310P.

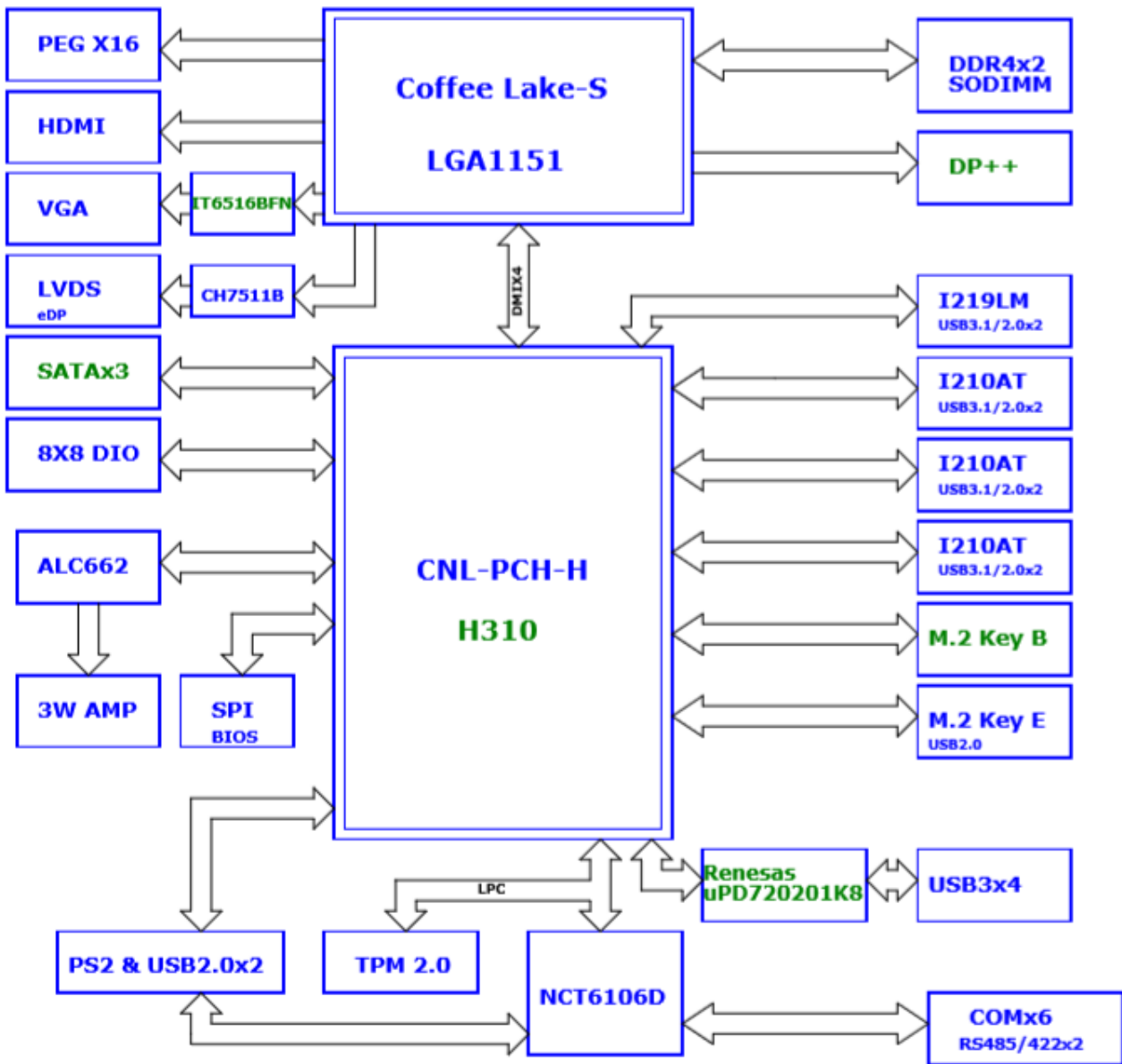

Note: Limitation regarding to Renesas uPD720201 PCIe to USB3.0 Performance.

2. Hardware Configuration

2.1 Product Overview

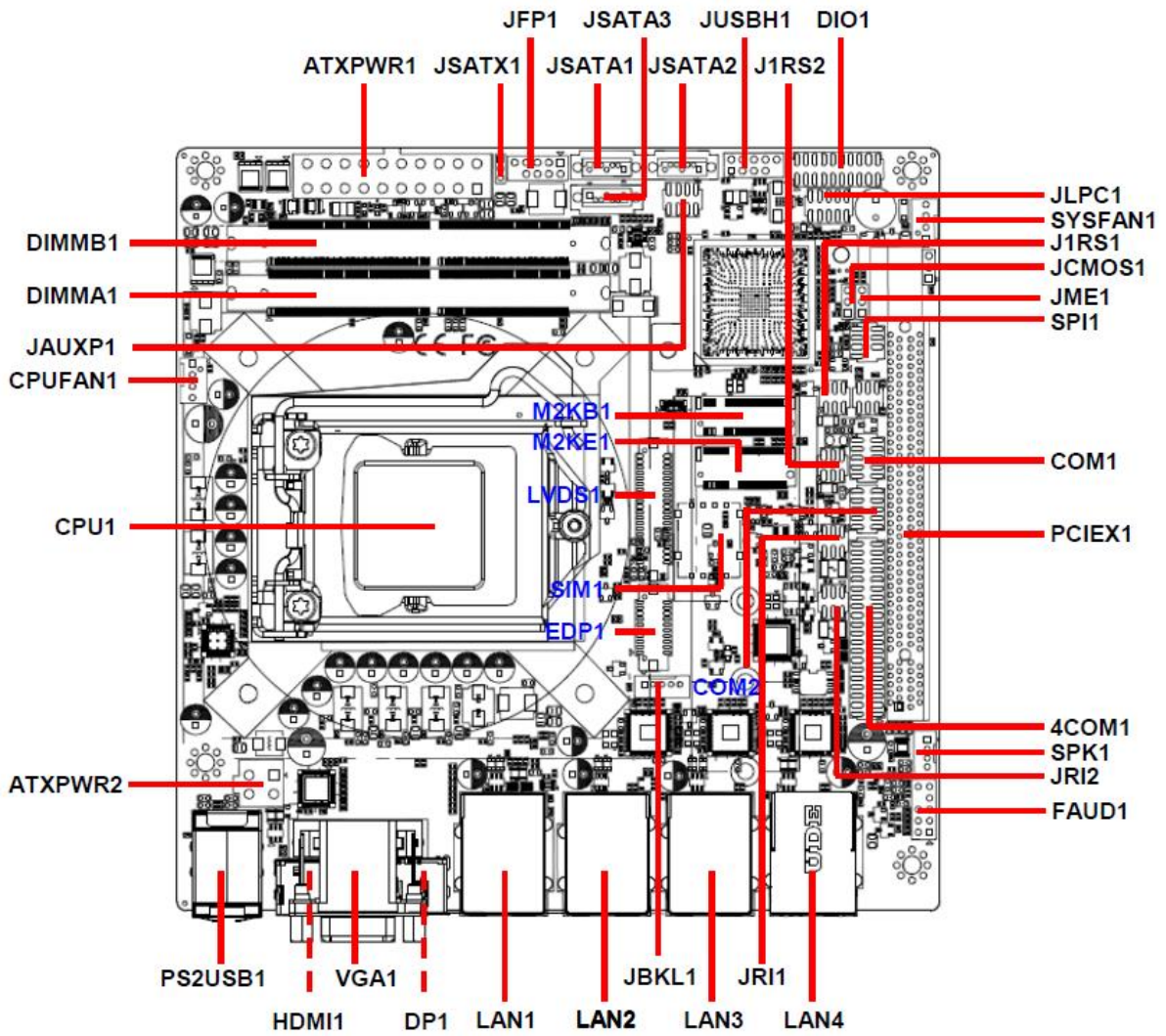

2.2 Jumper and Connector List

You can configure your board to match the needs of your application by setting jumpers. A jumper is the simplest kind of electric switch.

It consists of two metal pins and a small metal clip (often protected by a plastic cover) that slides over the pins to connect them. To “close” a jumper you connect the pins with the clip. To “open” a jumper you remove the clip. Sometimes a jumper will have three pins, labeled 1, 2, and 3. In this case, you would connect either two pins.

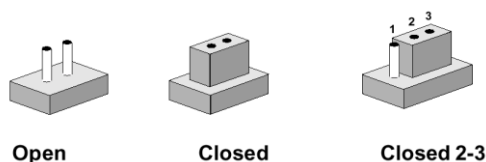

The jumper settings are schematically depicted in this manual as follows:

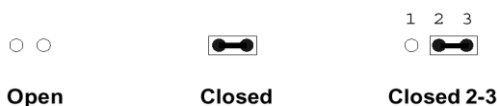

A pair of needle-nose pliers may be helpful when working with jumpers.

Connectors on the board are linked to external devices such as hard disk drives, a keyboard, or floppy drives. In addition, the board has a number of jumpers that allow you to configure your system to suit your application.

If you have any doubts about the best hardware configuration for your application, contact your local distributor or sales representative before you make any changes.

The following tables list the function of each of the board's jumpers and connectors.

Jumpers

Label	Function	Note
JRI1/2	Serial port 1/2 pin9 signal select	3 x 2 header, pitch 2.00mm
JME1	BIOS ME function configuration	3 x 1 header, pitch 2.54mm
JSATX1	AT/ATX Power Mode Select	3 x 1 header, pitch 2.00mm
JCMOS1	Clear CMOS	3 x 1 header, pitch 2.54mm

Connectors

Label	Function	Note
SYSFAN1	System fan connector 1 (with smart fan function supported)	4 x 1 wafer, pitch 2.54mm
CPUFAN1	CPU fan connector	4 x 1 wafer, pitch 2.54mm
JAUXP1	Auxiliary Panel connector	4 x 2 header, pitch 2.00mm
SPI1	Miscellaneous setting connector	4 x 2 header, pitch 2.00mm

EMX-H310P User's Manual

COM1/2	Serial Port1/2 connector	5 x 2 header, pitch 2.00 mm
FAUD1	Front Audio connector	5 x 2 header, pitch 2.54mm
DIO1	General purpose I/O connector	10 x 2 header, pitch 2.00mm
SPK1	Speaker connector	4 x 1 wafer, pitch 2.00 mm
JBKL1	LCD Inverter connector	5 x 1 wafer, pitch 2.00 mm
JFP1	Front Panel connector	5 x 2 header, pitch 2.54mm
LAN1/2/3/4	4 x RJ-45 with Dual deck USB 3.0 connector	
4COM1	Serial Port connector	20 x 2 header, pitch 2.00mm
JUSBH1	USB connector	10 x 2 wafer, pitch 2.00mm
EDP1	eDP-Panel connector	10 x 2 wafer, pitch 1.25mm
LVDS1	LVDS connector	20 x 2 wafer, pitch 1.25mm
J1RS1/2	J1RS1/2 connector	3 x 2 header, pitch 2.00 mm
JLPC1	LPC connector	5 x 2 header, pitch 2.00mm
ATXPWR1	ATX Power connector	10 x 2 wafer, pitch 4.20mm
ATXPWR2	ATX Power connector	2 x 2 wafer, pitch 4.20mm
HDMI1	HDMI connector	
JSATA1/2/3	Serial ATA connector	
DIMMA1	260-pin DIMM slot 1	
DIMMB1	260-pin DIMM slot 2	
M2KE1	M.2 Key E	
M2KB1	M.2 Key B	
PCIEX1	PCI-e x16 slot	
SIM1	SIM card slot	
CPU	CPU connector	
VGA1	VGA connector	
DP1	DP connector	
PS2USB1	PS2+USB connector	

2.3 Setting Jumpers & Connectors

2.3.1 Serial port 1 pin9 signal select (JR11)

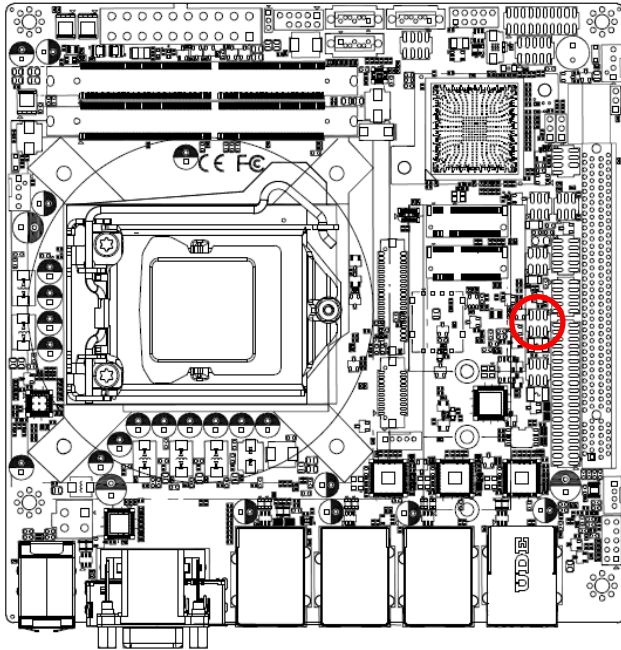

Ring*

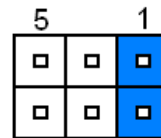

+12V

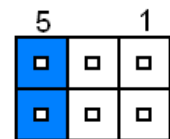

+5V

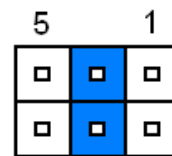

* Default

2.3.2 Serial port 2 pin9 signal select (JR12)

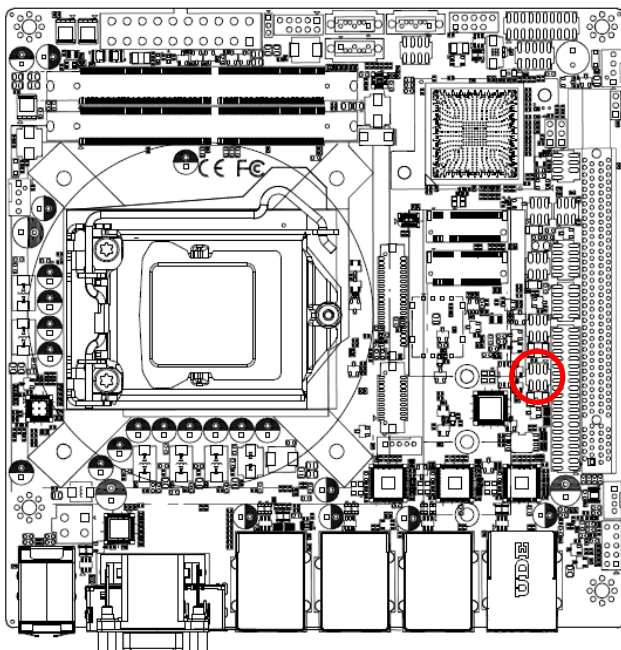

Ring*

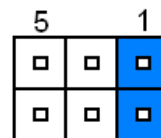

+12V

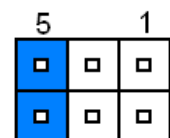

+5V

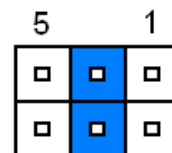

* Default

2.3.3 BIOS ME function configuration (JME1)

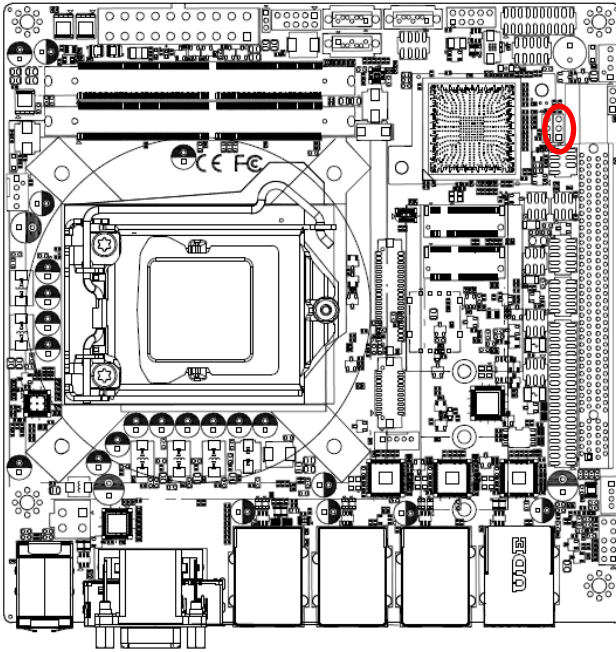

Enable ME *

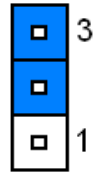

Disable ME

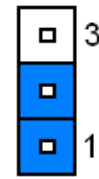

* Default

2.3.4 Clear CMOS (JCMOS1)

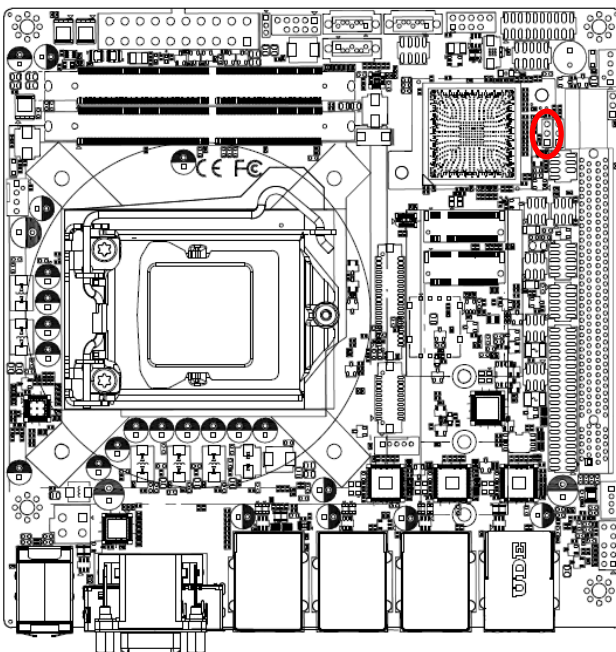

Protect*

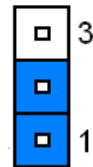

Clear CMOS

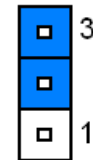

* Default

2.3.5 AT/ATX Power Mode Select (JSATX1)

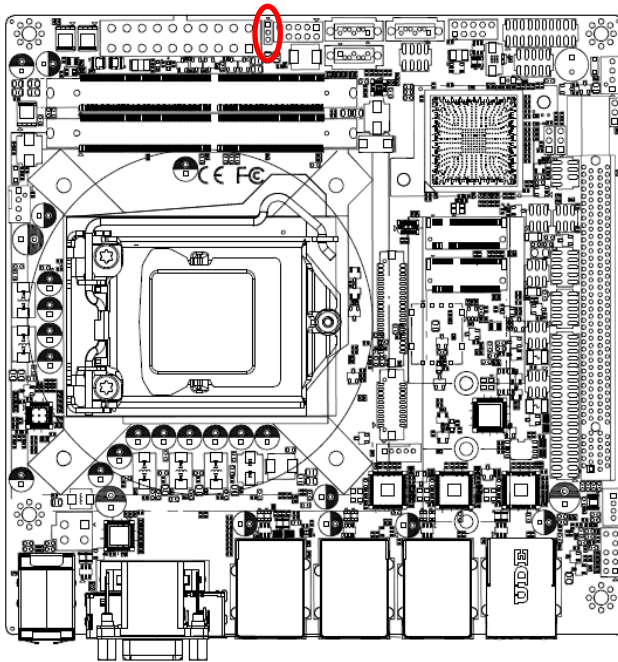

AT

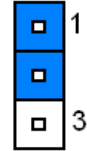

ATX*

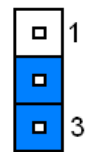

* Default

2.3.6 General purpose I/O connector (DIO1)

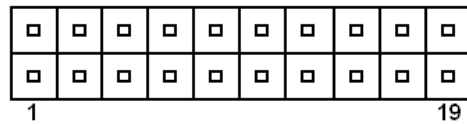
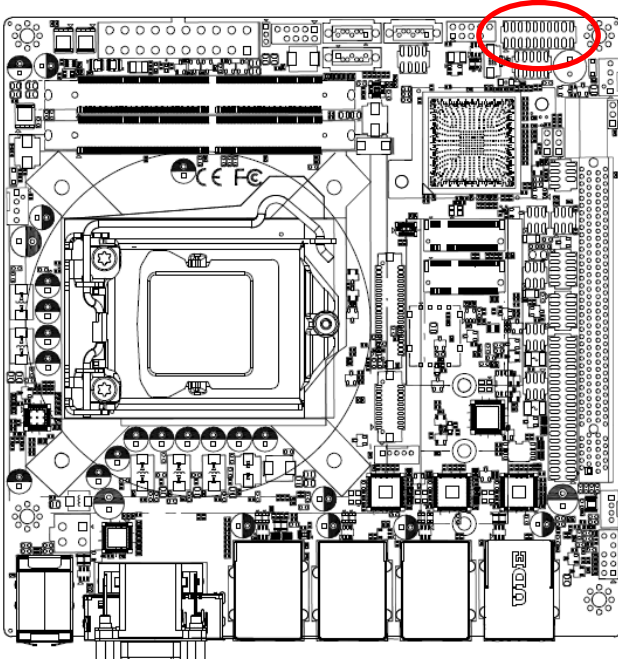

Signal	PIN	PIN	Signal
DI0	1	2	DO0
DI1	3	4	DO1
DI2	5	6	DO2
DI3	7	8	DO3
DI4	9	10	DO4
DI5	11	12	DO5
DI6	13	14	DO6
DI7	15	16	DO7
5V_SMB_CLK	17	18	5V_SMB_DATA
GND	19	20	+5V

2.3.7 ATX Power connector (ATXPWR2)

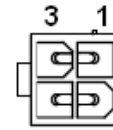
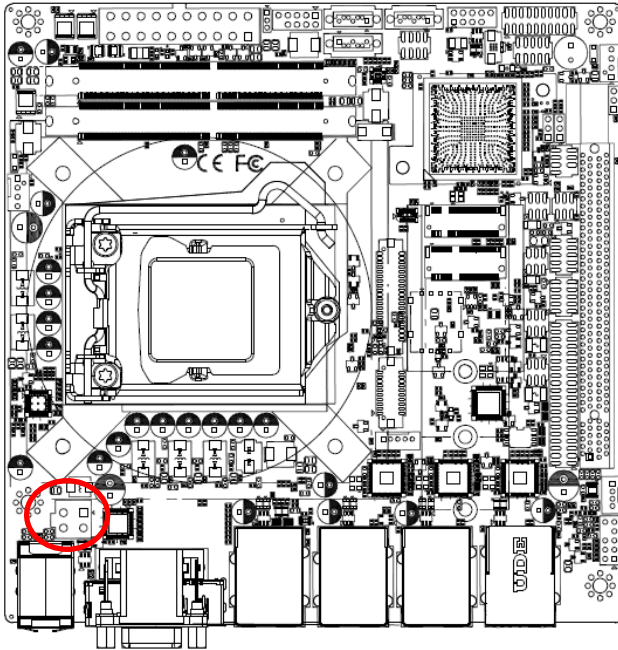

Signal	PIN	PIN	Signal
+V12S_CPU	3	1	GND
+V12S_CPU	4	2	GND

2.3.8 USB connector (JUSBH1)

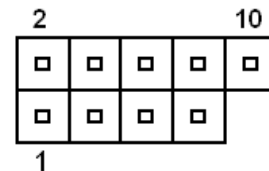
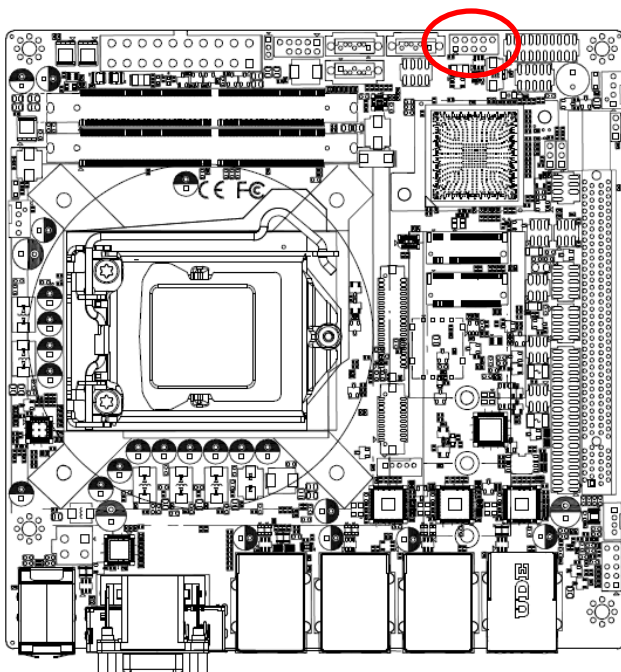

Signal	PIN	PIN	Signal
+V5A_USB_H123	1	2	+V5A_USB_H123
USB_HDN1	3	4	USB_HDN2
USB_HDP1	5	6	USB_HDP2
GND	7	8	GND
		10	NC

2.3.9 LPC connector (JLPC1)

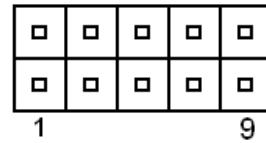
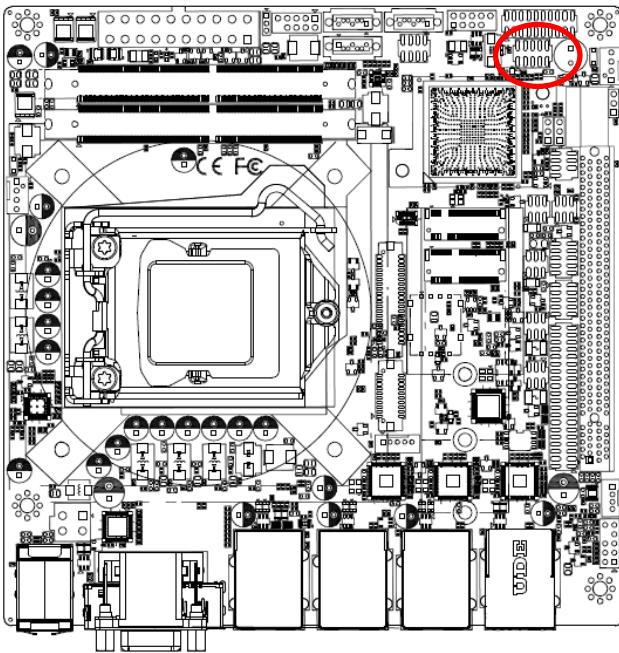

Signal	PIN	PIN	Signal
LPC_AD0	1	2	+3.3V
LPC_AD1	3	4	PLT_RST#_BUF
LPC_AD2	5	6	LPC_FRAME#
LPC_AD3	7	8	LPC_DEG_CLK
LPC_SERIRQ	9	10	GND

2.3.10 Miscellaneous setting connector (SPI1)

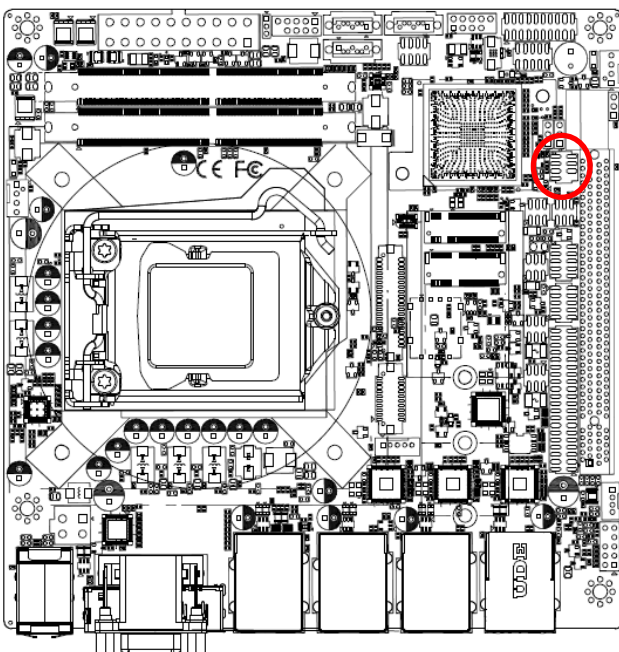

Signal	PIN	PIN	Signal
+ V3.3A_SPI	1	2	GND
SPI_CS0#	3	4	SPI_CLK
SPI_MISO	5	6	SPI_MOSI
SPI_HOLD#	7		

2.3.11 Speaker connector (SPK1)

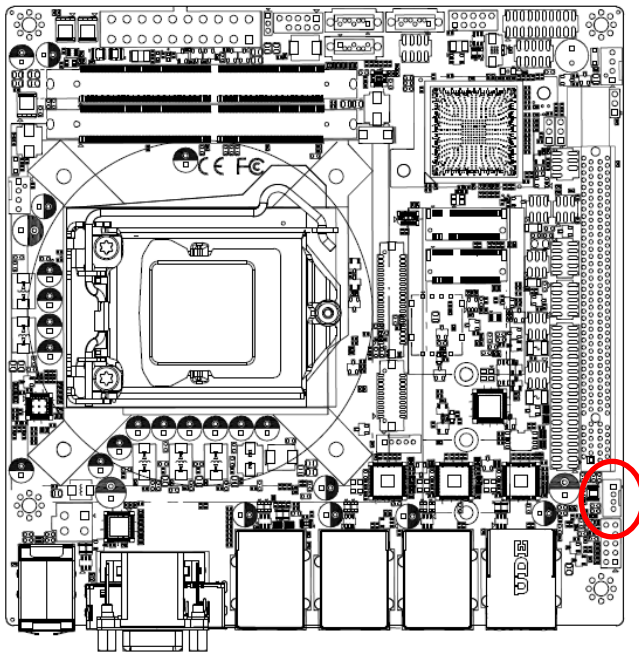

Signal	PIN
LSPK+	1
LSPK-	2
RSPK+	3
RSPK-	4

2.3.12 LCD Inverter connector (JBKL1)

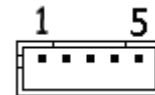
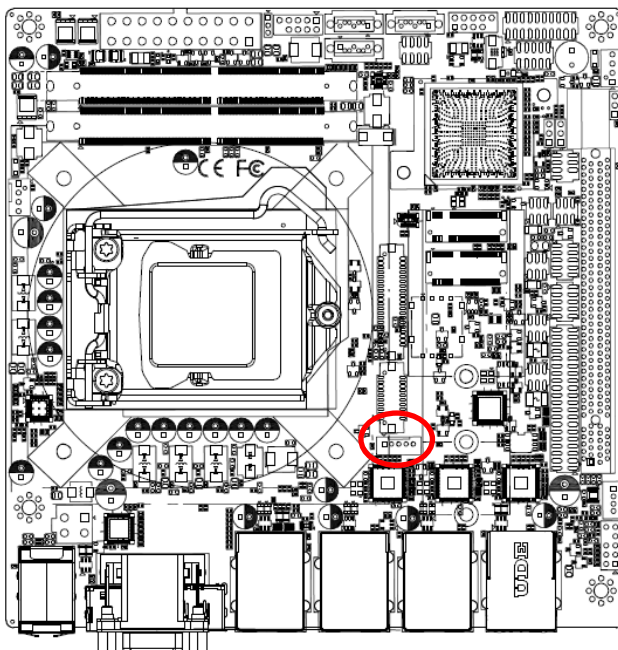

Signal	PIN
+12V	1
GND	2
LVDS_BKLTEN	3
LVDS_BKLADJ	4
+5V	5

2.3.13 Front Panel connector (JFP1)

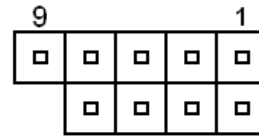
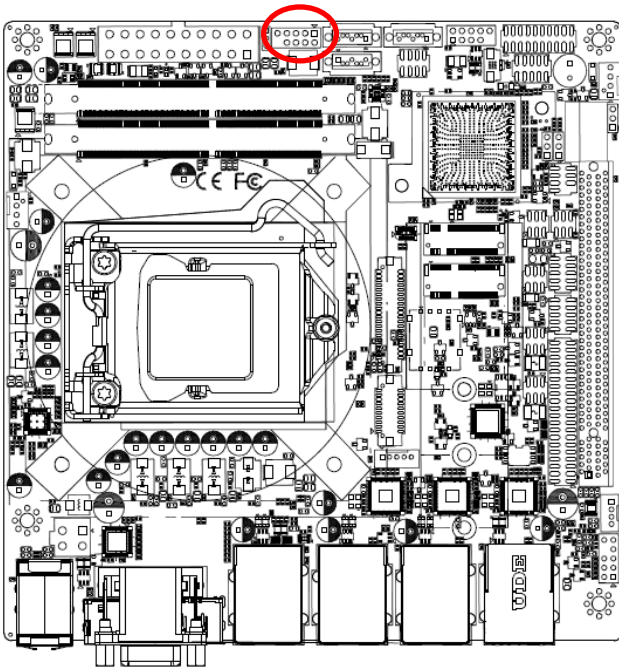

Signal	PIN	PIN	Signal
HDD_LED+	1	2	PWR_LED+
HDD_LED-	3	4	PWR_LED-
SYS_RST#	5	6	PWRBTN#
GND	7	8	GND
NC	9		

2.3.14 CPU fan connector (CPUFAN1)

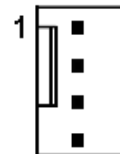
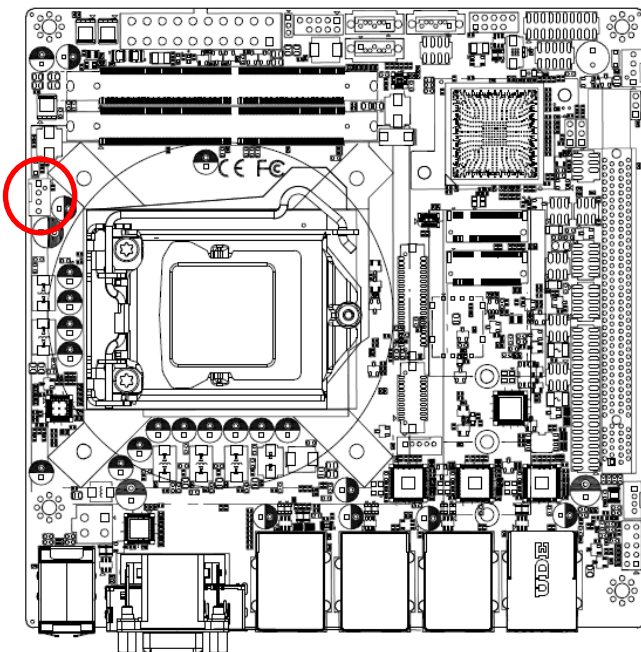

PIN	Signal
1	GND
2	+12V
3	CPU_R_FANIN
4	CPU_FANOUT

2.3.15 System fan connector (SYSFAN1)

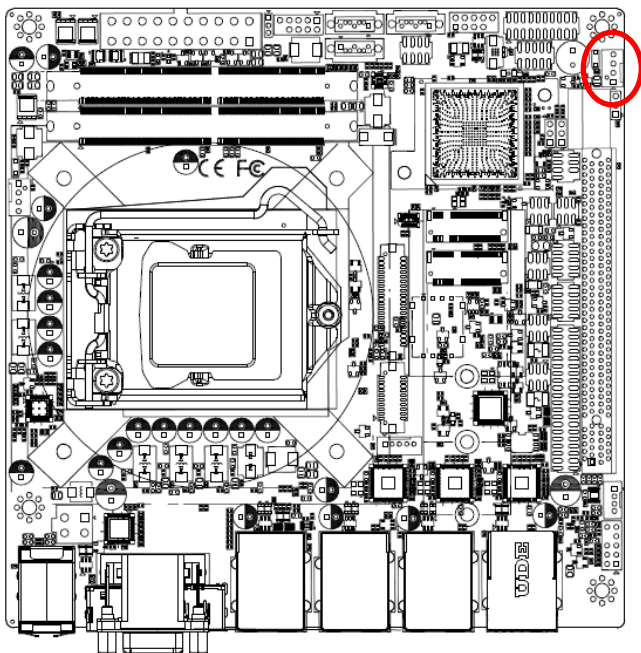

PIN	Signal
4	SYS_FANOUT
3	SYS_R_FANIN
2	+12V
1	GND

2.3.16 ATX Power connector (ATXPWR1)

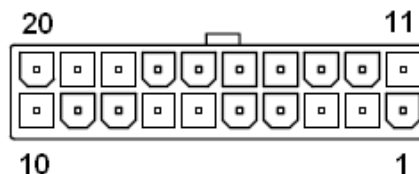
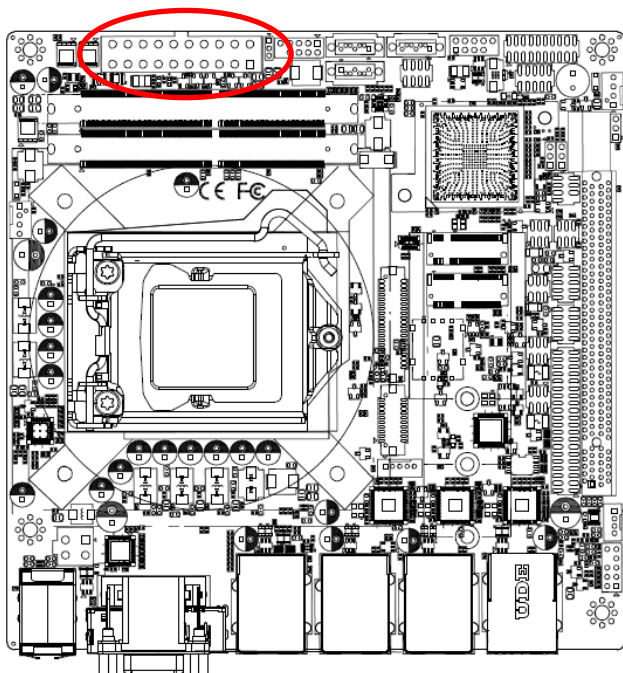

Signal	PIN	PIN	Signal
+3.3V	11	1	+3.3V
NC	12	2	+3.3V
GND	13	3	GND
ATX_PSON#	14	4	+5V
GND	15	5	GND
GND	16	6	+5V
GND	17	7	GND
NC	18	8	ATX20_PWROK
+5V	19	9	+V5A_SB
GND	20	10	+12V

2.3.17 Serial port connector (COM1)

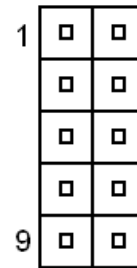
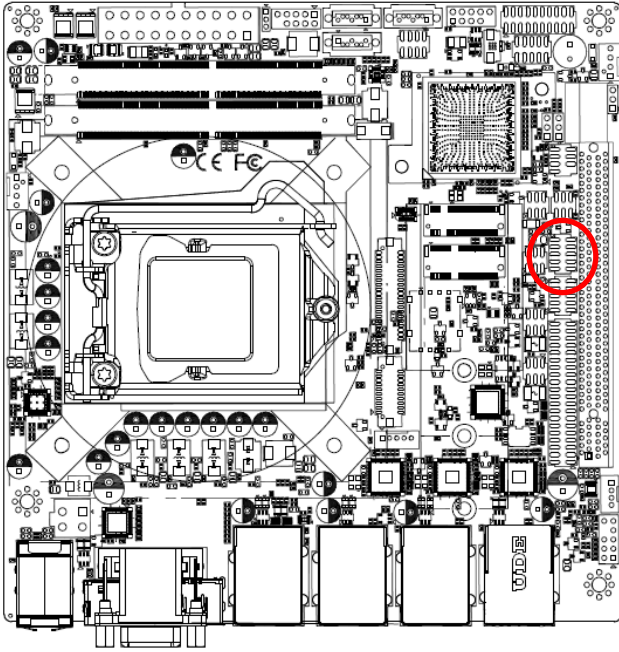

Signal	PIN	PIN	Signal
NDCDA#	1	2	NRXDA
NTXDA	3	4	NDTRA#
GND	5	6	NDSRA#
NRTSA#	7	8	NCTSA#
NRIA#	9	10	NC

2.3.18 Serial port connector (COM2)

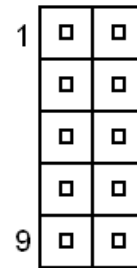
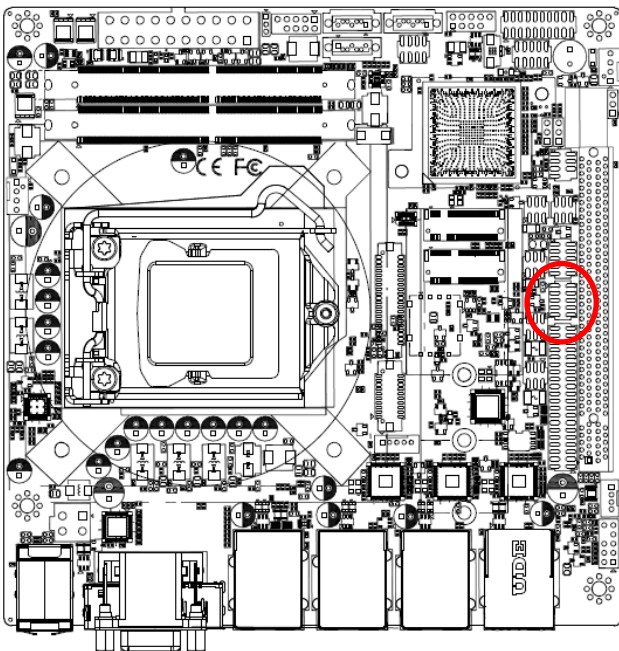

Signal	PIN	PIN	Signal
NDCDB#	1	2	NRXDB
NTXDB	3	4	NDTRB#
GND	5	6	NDSRB#
NRTSB#	7	8	NCTSB#
NRIB#	9	10	NC

2.3.19 J1RS1 connector (J1RS1)

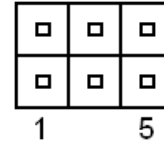
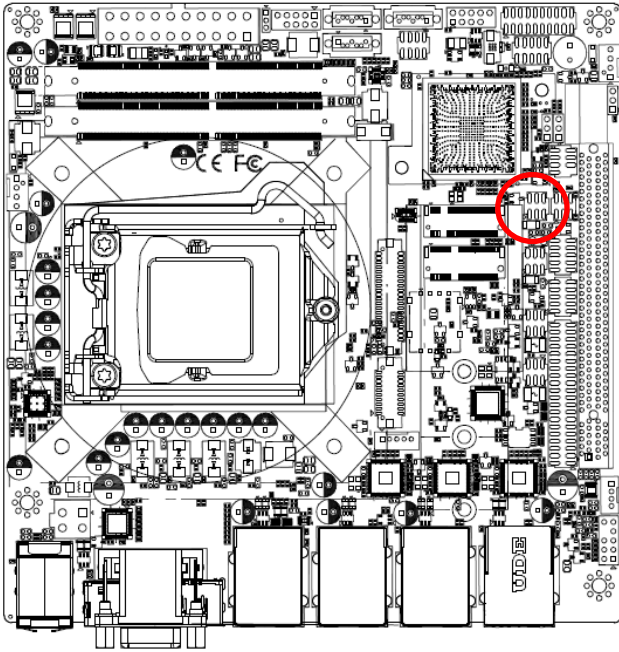

Signal	PIN	PIN	Signal
A485TX-	1	2	A422RX-
A485TX+	3	4	A422RX+
+5V	5	6	GND

2.3.20 J1RS2 connector (J1RS2)

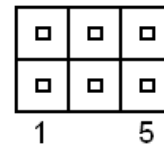
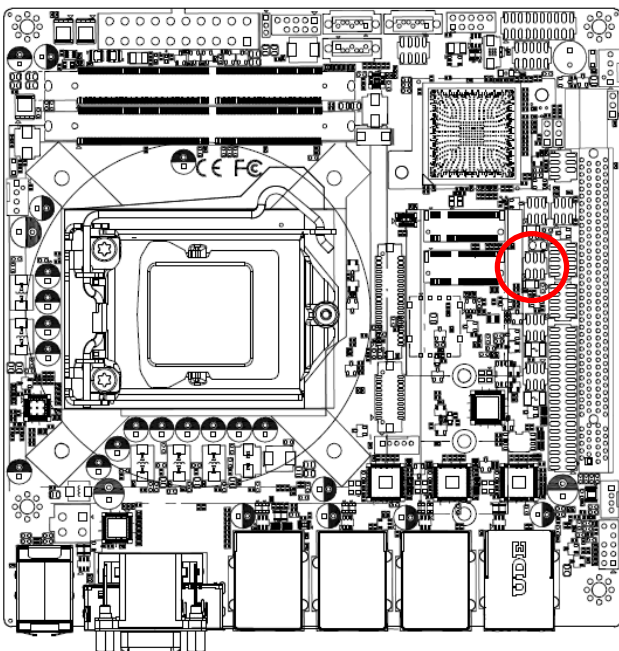

Signal	PIN	PIN	Signal
B485TX-	1	2	B422RX-
B485TX+	3	4	B422RX+
+5V	5	6	GND

2.3.21 Auxiliary Panel connector (JAUXP1)

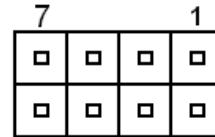
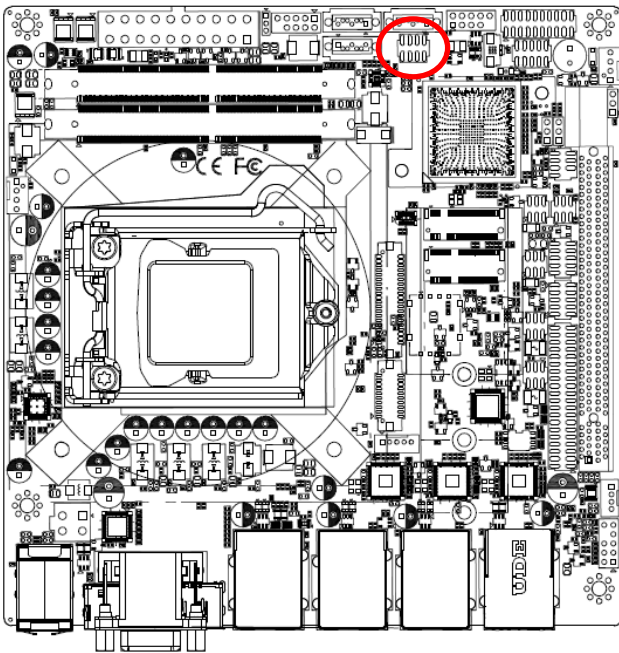

Signal	PIN	PIN	Signal
FRONT_LAN1_ACT	1	2	GND
FRONT_LAN2_ACT	3	4	GND
FRONT_LAN3_ACT	5	6	GND
FRONT_LAN4_ACT	7	8	GND

2.3.22 eDP-Panel connector (EDP 1)

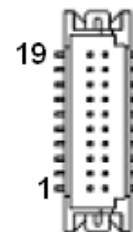
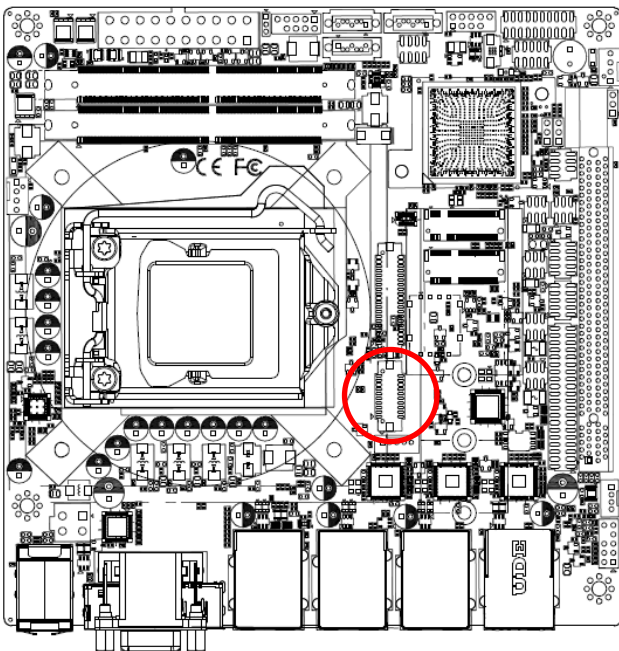

Signal	PIN	PIN	Signal
EDP_VCC_PAL	19	20	EDP_VCC_PAL
EDP_TXP2	17	18	EDP_C_HPD
EDP_TXN2	15	16	GND
GND	13	14	EDP_AUXP
EDP_TXP1	11	12	EDP_AUXN
EDP_TXN1	9	10	GND
GND	7	8	NC
EDP_TXP0	5	6	EDP_TXP3
EDP_TXN0	3	4	EDP_TXN3
GND	1	2	GND

2.3.23 LVDS connector (LVDS1)

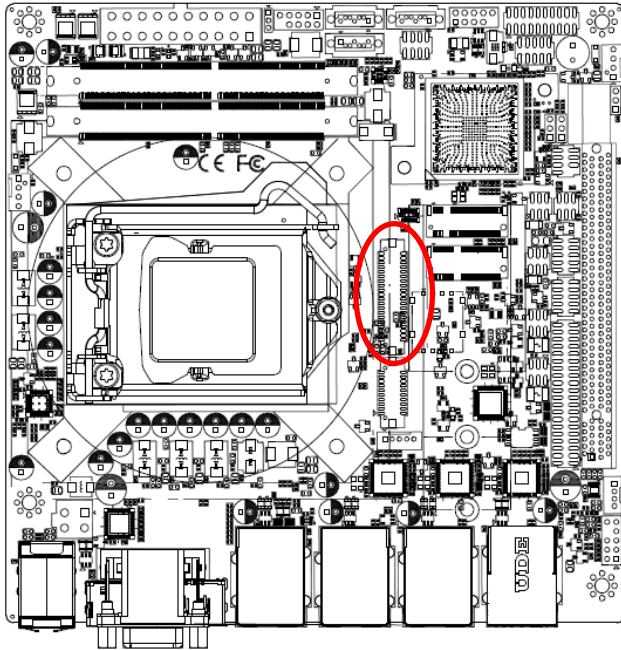

Signal	PIN	PIN	Signal
LVDS_VDD12V	39	40	LVDS_VDD12V
GND	37	38	GND
LVDS_CLK2N	35	36	LVDS_CLK1N
LVDS_CLK2P	33	34	LVDS_CLK1P
GND	31	32	GND
LVDS_DATAN7	29	30	LVDS_DATAN6
LVDS_DATAP7	27	28	LVDS_DATAP6
GND	25	26	GND
LVDS_DATAN5	23	24	LVDS_DATAN4
LVDS_DATAP5	21	22	LVDS_DATAP4
GND	19	20	GND
LVDS_DATAN3	17	18	LVDS_DATAN2
LVDS_DATAP3	15	16	LVDS_DATAP2
GND	13	14	GND
LVDS_DATAN1	11	12	LVDS_DATAN0
LVDS_DATAP1	9	10	LVDS_DATAP0
GND	7	8	GND
NC	5	6	NC
LVDS_VDD33V	3	4	LVDS_VDD5V
LVDS_VDD33V	1	2	LVDS_VDD5V

2.3.24 Serial port connector (4COM1)

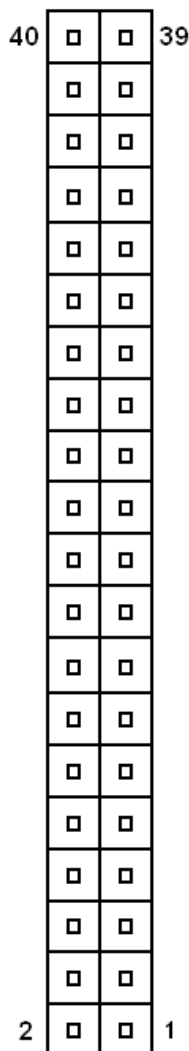
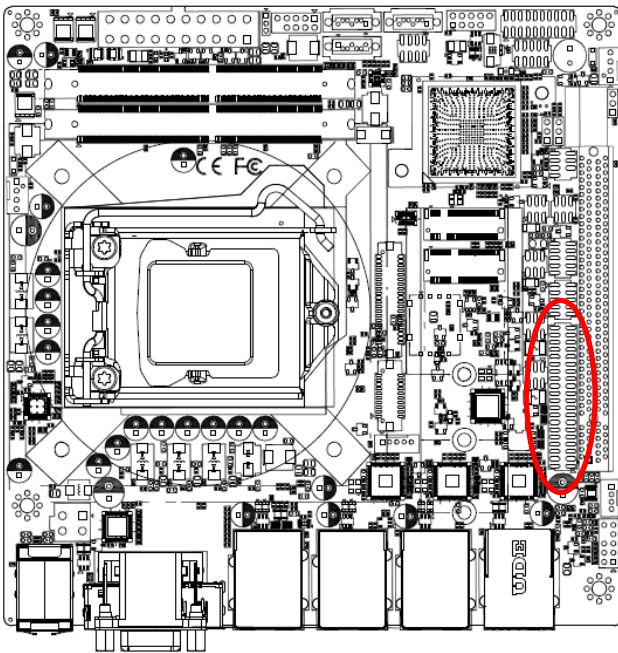

Signal	PIN	PIN	Signal
NC	40	39	NRIF#
NCTSF#	38	37	NRTSF#
NDSRF#	36	35	GND
NDTRF#	34	33	NTXDF
NRXDF	32	31	NDCDF#
NC	30	29	NRIE#
NCTSE#	28	27	NRTSE#
NDSRE#	26	25	GND
NDTRE#	24	23	NTXDE
NRXDE	22	21	NDCDE#
NC	20	19	NRID#
NCTSD#	18	17	NRTSD#
NDSRD#	16	15	GND
NDTRD#	14	13	NTXDD
NRXDD	12	11	NDCDD#
NC	10	9	NRIC#
NCTSC#	8	7	NRTSC#
NDSRC#	6	5	GND
NDTRC#	4	3	NTXDC
NRXDC	2	1	NDCDC#

2.3.25 Audio connector (FAUD1)

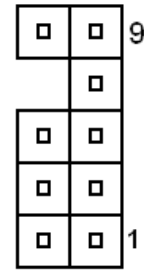
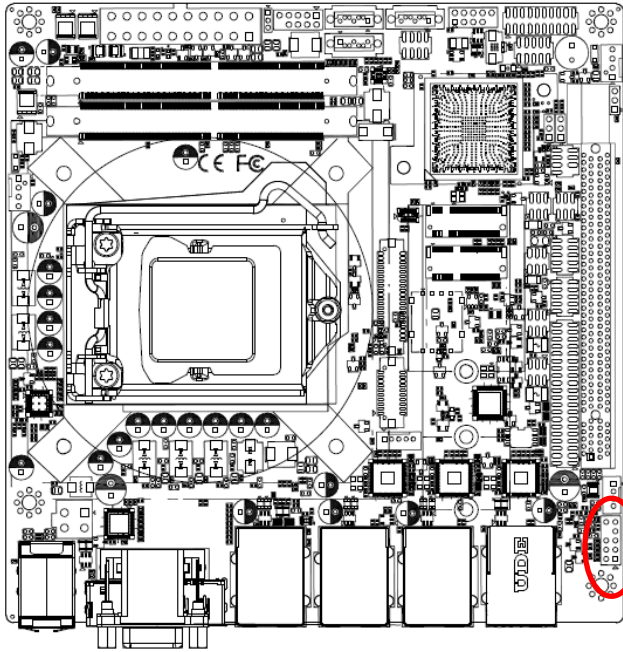

Signal	PIN	PIN	Signal
LINE2_JD	10	9	LINE2_L
		7	SENSE_B
MIC2_JD	6	5	LINE2_R
AUD_FRONT_DET#	4	3	MIC2_R
GND	2	1	MIC2_L

3. BIOS Setup

3.1 Introduction

The BIOS setup program allows users to modify the basic system configuration. In this following chapter will describe how to access the BIOS setup program and the configuration options that may be changed.

3.2 Starting Setup

The AMI BIOS™ is immediately activated when you first power on the computer. The BIOS reads the system information contained in the NVRAM and begins the process of checking out the system and configuring it. When it finishes, the BIOS will seek an operating system on one of the disks and then launch and turn control over to the operating system.

While the BIOS is in control, the Setup program can be activated in one of two ways:

By pressing or <F2> immediately after switching the system on, or

By pressing the or <F2> key when the following message appears briefly at the left-top of the screen during the POST (Power On Self Test).

Press or <F2> to enter SETUP

If the message disappears before you respond and you still wish to enter Setup, restart the system to try again by turning it OFF then ON or pressing the "RESET" button on the system case. You may also restart by simultaneously pressing <Ctrl>, <Alt>, and <Delete> keys. If you do not press the keys at the correct time and the system does not boot, an error message will be displayed and you will again be asked to.

Press F1 to Continue, DEL to enter SETUP

3.3 Using Setup

In general, you use the arrow keys to highlight items, press <Enter> to select, use the PageUp and PageDown keys to change entries, press <F1> for help and press <Esc> to quit. The following table provides more detail about how to navigate in the Setup program using the keyboard.

Button	Description
↑	Move to previous item
↓	Move to next item
←	Move to the item in the left hand
→	Move to the item in the right hand
Esc key	Main Menu -- Quit and not save changes into NVRAM Status Page Setup Menu and Option Page Setup Menu -- Exit current page and return to Main Menu
+ key	Increase the numeric value or make changes
- key	Decrease the numeric value or make changes
F1 key	General help, only for Status Page Setup Menu and Option Page Setup Menu
F2 key	Previous Values.
F3 key	Optimized defaults
F4 key	Save & Exit Setup

- **Navigating Through The Menu Bar**

Use the left and right arrow keys to choose the menu you want to be in.



Note: Some of the navigation keys differ from one screen to another.

- **To Display a Sub Menu**

Use the arrow keys to move the cursor to the sub menu you want. Then press <Enter>. A “>” pointer marks all sub menus.

3.4 Getting Help

Press F1 to pop up a small help window that describes the appropriate keys to use and the possible selections for the highlighted item. To exit the Help Window press <Esc> or the F1 key again.

3.5 In Case of Problems

If, after making and saving system changes with Setup, you discover that your computer no longer is able to boot, the AMI BIOS supports an override to the NVRAM settings which resets your system to its defaults.

The best advice is to only alter settings which you thoroughly understand. To this end, we strongly recommend that you avoid making any changes to the chipset defaults. These defaults have been carefully chosen by both BIOS Vendor and your systems manufacturer to provide the absolute maximum performance and reliability. Even a seemingly small change to the chipset setup has the potential for causing you to use the override.

3.6 BIOS setup

Once you enter the Aptio Setup Utility, the Main Menu will appear on the screen. The Main Menu allows you to select from several setup functions and exit choices. Use the arrow keys to select among the items and press <Enter> to accept and enter the sub-menu.

3.6.1 Main Menu

This section allows you to record some basic hardware configurations in your computer and set the system clock.

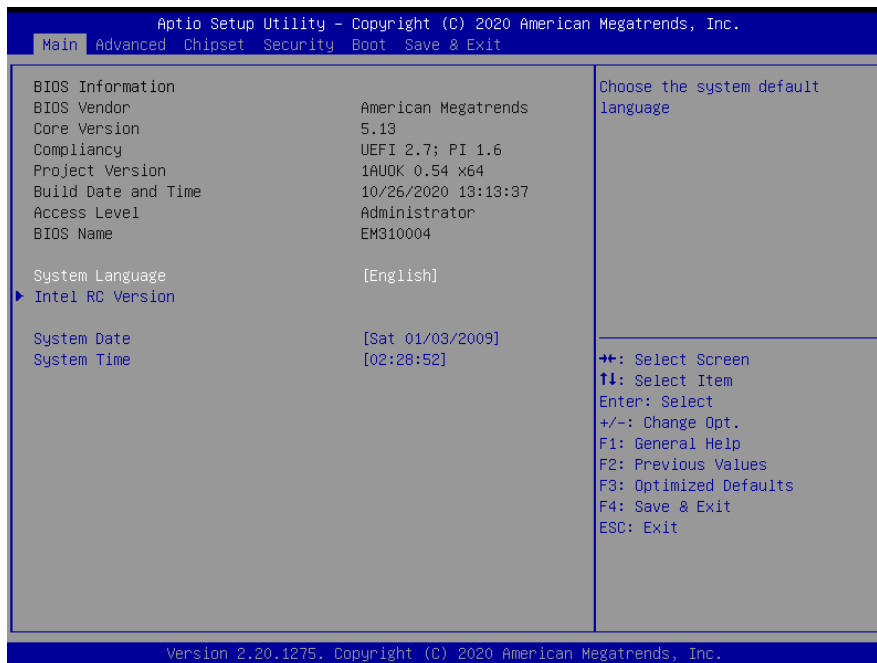

EMX-H310P User's Manual

3.6.1.1 System Language

This option allows choosing the system default language.

3.6.1.2 System Date

Use the system date option to set the system date. Manually enter the day, month and year.

3.6.1.3 System Time

Use the system time option to set the system time. Manually enter the hours, minutes and seconds.



Note: The BIOS setup screens shown in this chapter are for reference purposes only, and may not exactly match what you see on your screen.

Visit the Avalue website (www.avalue.com.tw) to download the latest product and BIOS information.

3.6.2 Advanced Menu

This section allows you to configure your CPU and other system devices for basic operation through the following sub-menus.

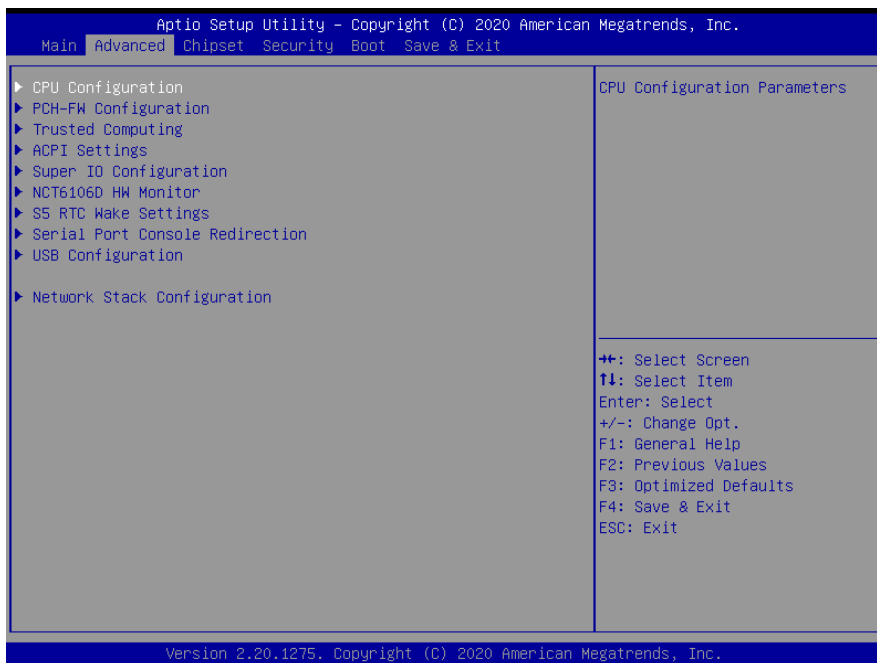

3.6.2.1 CPU Configuration

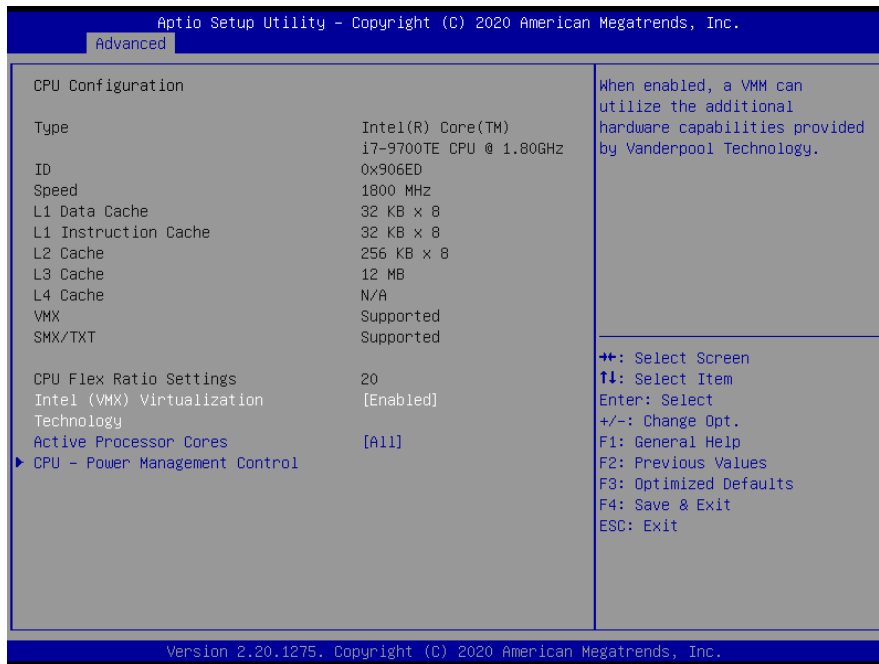

Item	Options	Description
Intel (VMX) Virtualization Technology	Disabled Enabled[Default],	When enabled, a VMM can utilize the additional hardware capabilities provided by Vanderpool Technology.
Active Processor Cores	All[Default], 1 2 3 4 5 6 7 8	Number of cores to enable in each processor package.

3.6.2.1.1 CPU - Power Management Control

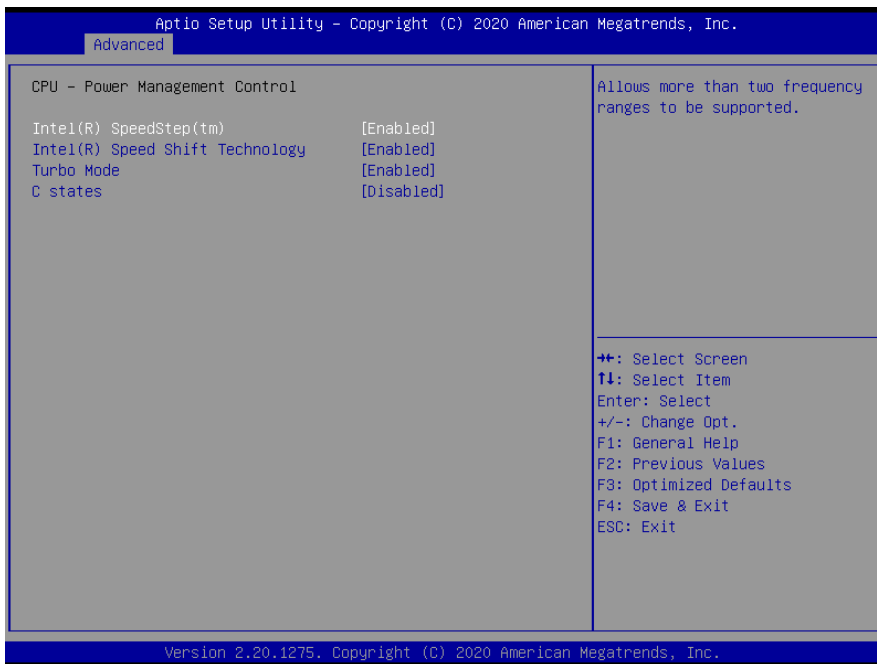

Item	Options	Description
Intel(R) SpeedStep(tm)	Disabled Enabled[Default],	Allows more than two frequency ranges to be supported.
Intel(R) Speed Shift Technology	Disabled Enabled[Default],	Enable/Disable Intel(R) Speed Shift Technology support. Enabling will expose the CPPC v2 interface to allow for hardware controlled P-states.
Turbo Mode	Disabled Enabled[Default],	Enable/Disable processor Turbo Mode (requires Intel Speed Step or Intel Speed Shift to be available and enabled).
C states	Disabled Enabled[Default],	Enable/Disable CPU Power Management. Allows CPU to go to C states when it’s not 100% utilized

3.6.2.2 PCH-FW Configuration

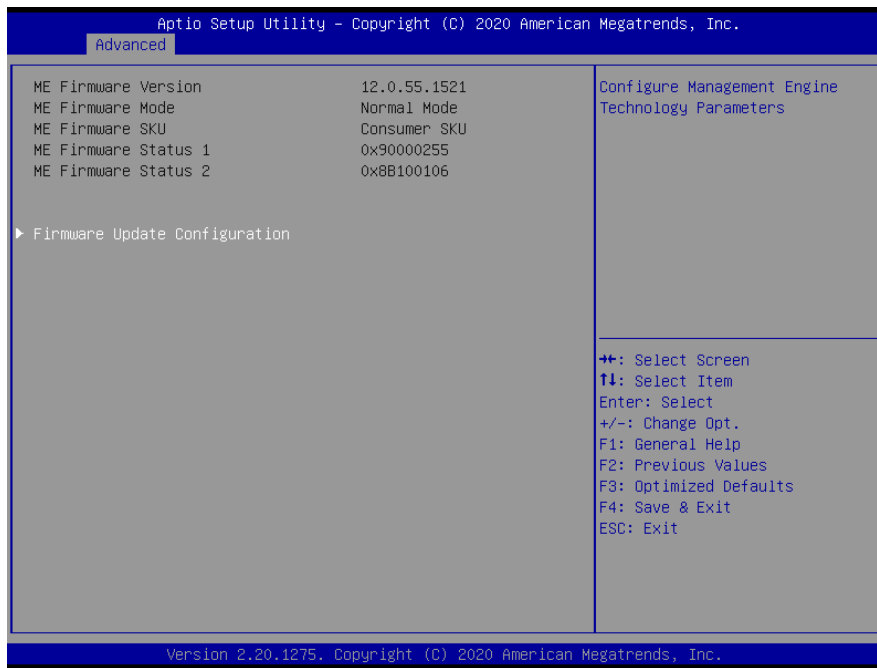

3.6.2.2.1 Firmware Update Configuration

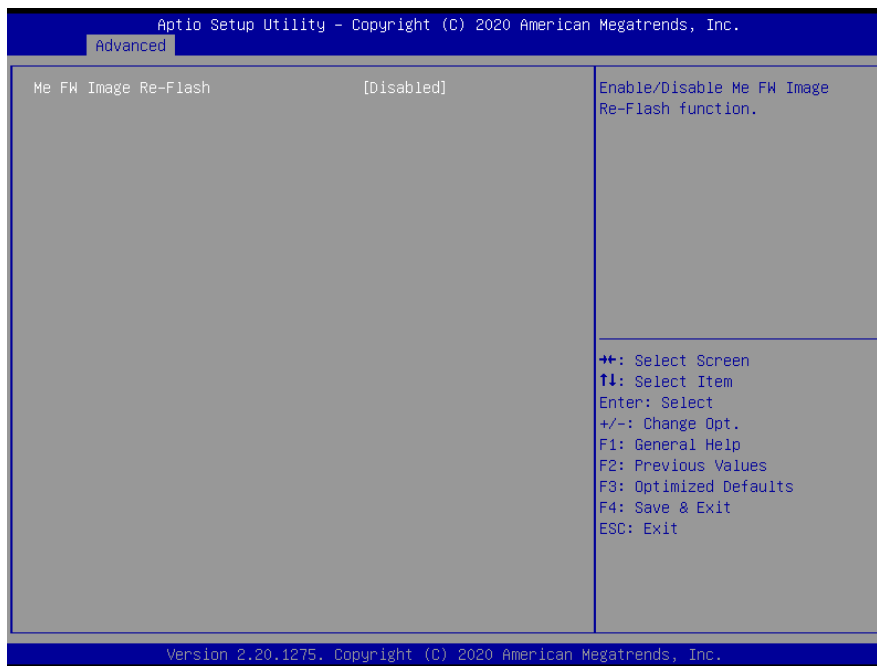

Item	Option	Description
Me FW Image Re-Flash	Disabled[Default], Enabled	Enable/Disable Me FW Image Re-Flash function.

3.6.2.3 Trusted Computing



Item	Options	Description
Security Device Support	Disable, Enable[Default]	Enables or Disables BIOS support for security device. O.S. will not show Security Device. TCG EFI protocol and INT1A interface will not be available.

3.6.2.4 ACPI Settings

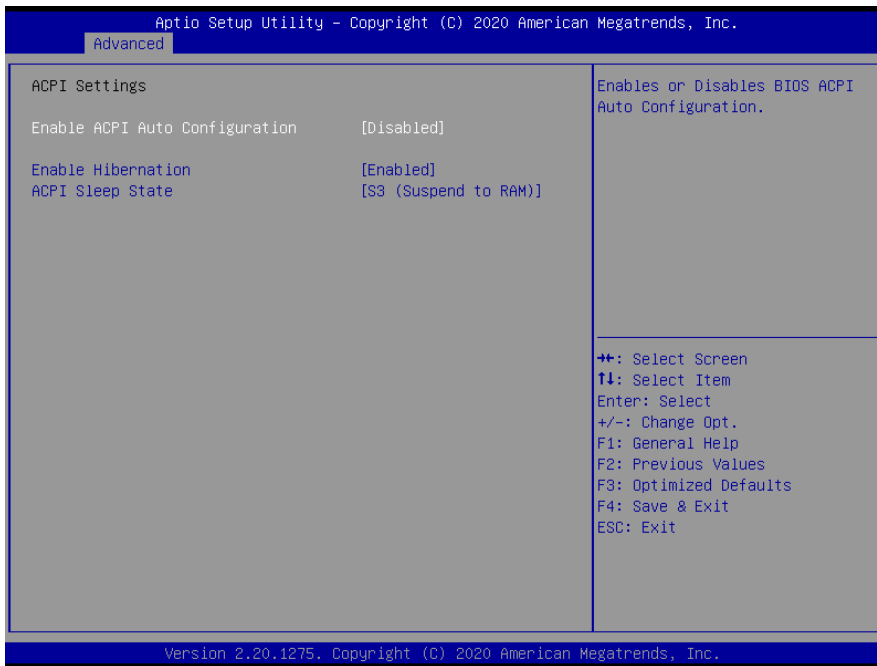

Item	Options	Description
Enable ACPI Auto Configuration	Disabled[Default], Enabled	Enables or Disables BIOS ACPI Auto Configuration.

Enable Hibernation	Disabled Enabled[Default],	Enables or Disables System ability to Hibernate (OS/S4 Sleep State). This option may not be effective with some operating systems.
ACPI Sleep State	Suspend Disabled, S3 (Suspend to RAM)[Default]	Select the highest ACPI sleep state the system will enter when the SUSPEDN button is pressed.

3.6.2.5 Super IO Configuration

You can use this item to set up or change the Super IO configuration for serial ports. Please refer to 3.6.2.5.1~ 3.6.2.5.6 for more information.

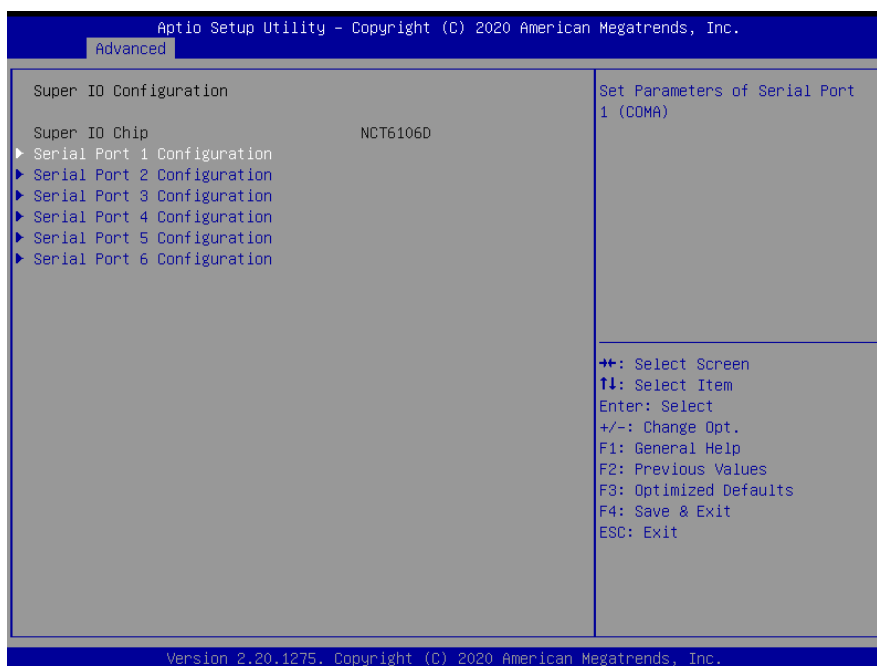

Item	Description
Serial Port 1 Configuration	Set Parameters of Serial Port 1 (COMA).
Serial Port 2 Configuration	Set Parameters of Serial Port 2 (COMB).
Serial Port 3 Configuration	Set Parameters of Serial Port 3 (COMC).
Serial Port 4 Configuration	Set Parameters of Serial Port 4 (COMD).
Serial Port 5 Configuration	Set Parameters of Serial Port 5 (COME).
Serial Port 6 Configuration	Set Parameters of Serial Port 6 (COMF).

3.6.2.5.1 Serial Port 1 Configuration

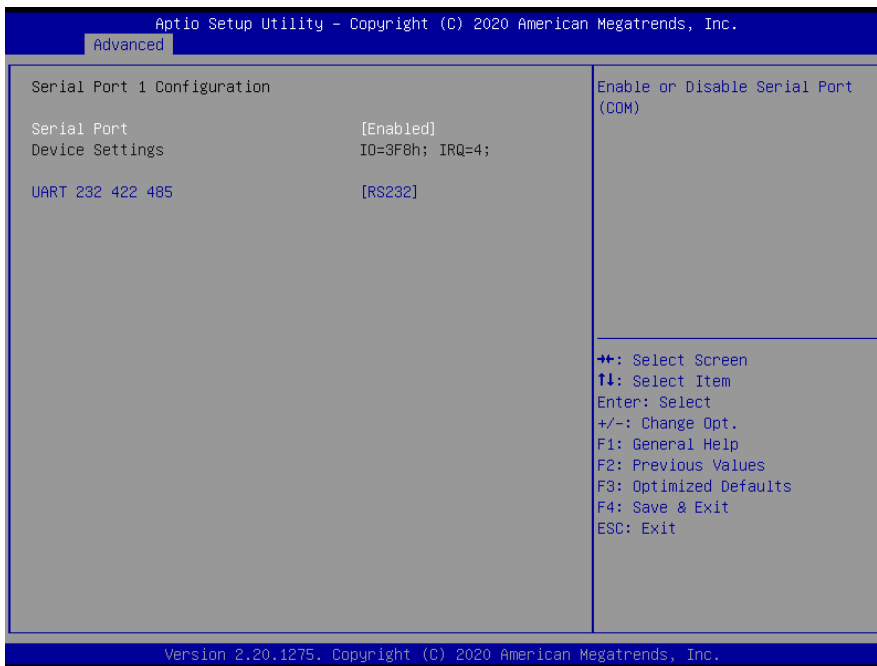

Item	Option	Description
Serial Port	Disabled Enabled[Default],	Enable or Disable Serial Port (COM).
UART 232 422 485	RS232[Default], RS422 RS485	Set COM Port as RS232, RS422 or RS485 mode.

3.6.2.5.2 Serial Port 2 Configuration

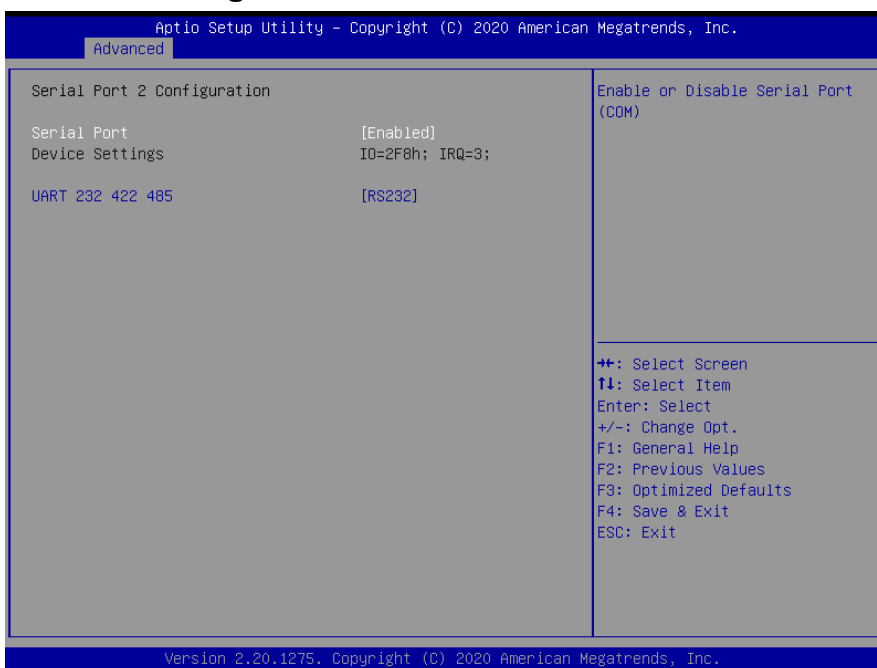

Item	Option	Description
Serial Port	Disabled Enabled[Default],	Enable or Disable Serial Port (COM).
UART 232 422 485	RS232[Default], RS422 RS485	Set COM Port as RS232, RS422 or RS485 mode.

3.6.2.5.3 Serial Port 3 Configuration

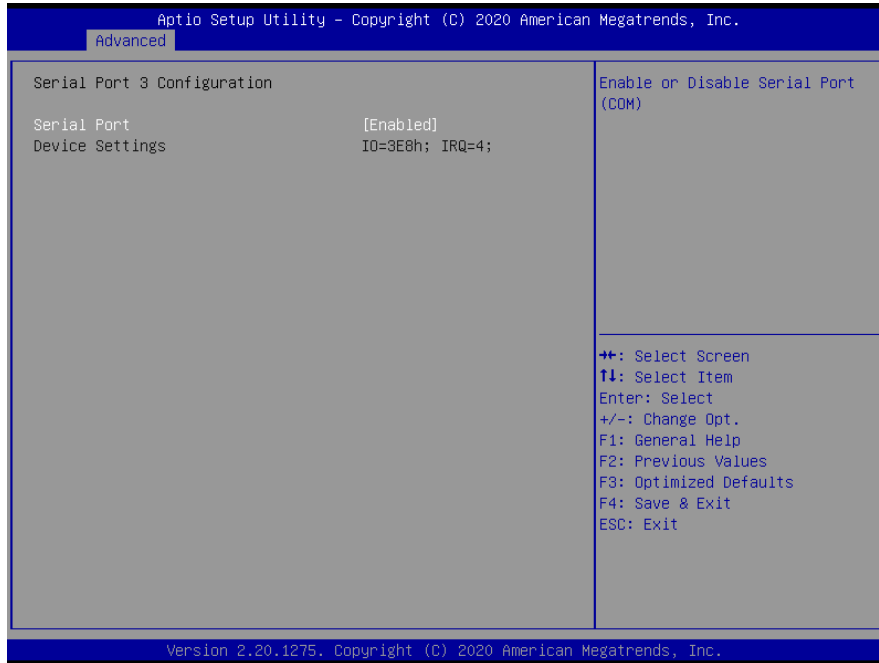

Item	Option	Description
Serial Port	Disabled Enabled[Default],	Enable or Disable Serial Port (COM).

3.6.2.5.4 Serial Port 4 Configuration

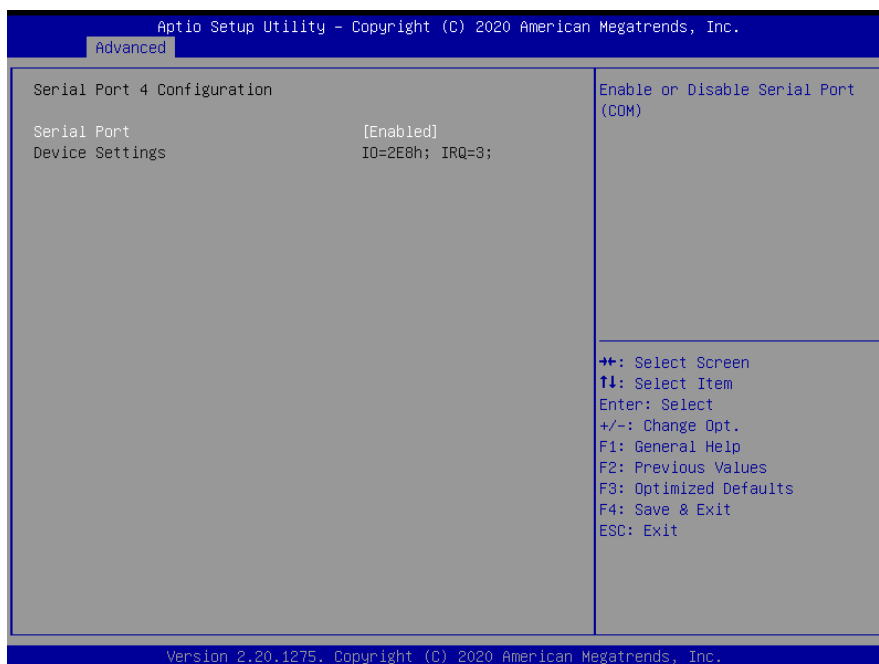

Item	Option	Description
Serial Port	Disabled Enabled[Default],	Enable or Disable Serial Port (COM).

3.6.2.5.5 Serial Port 5 Configuration

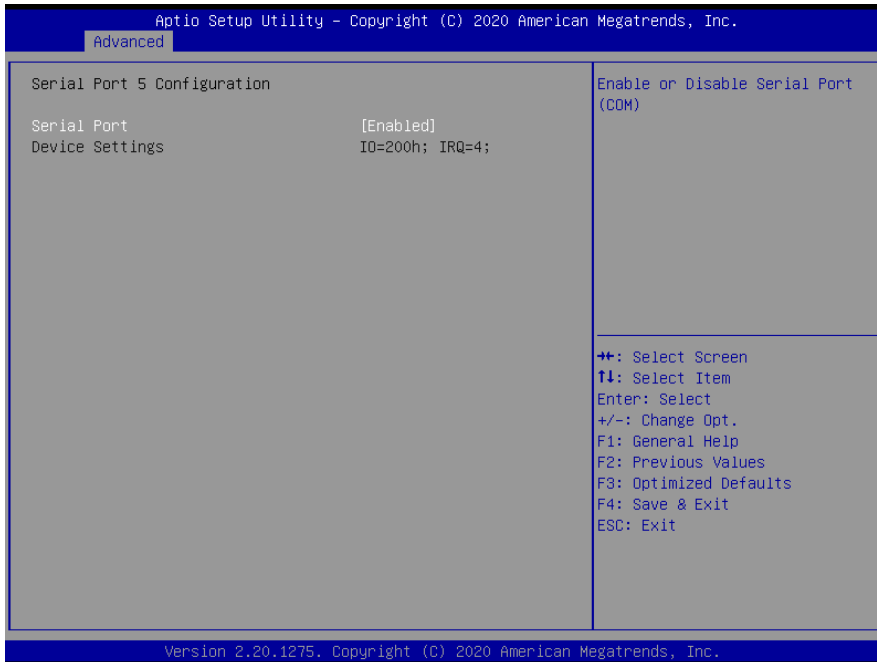

Item	Option	Description
Serial Port	Disabled Enabled[Default],	Enable or Disable Serial Port (COM).

3.6.2.5.6 Serial Port 6 Configuration

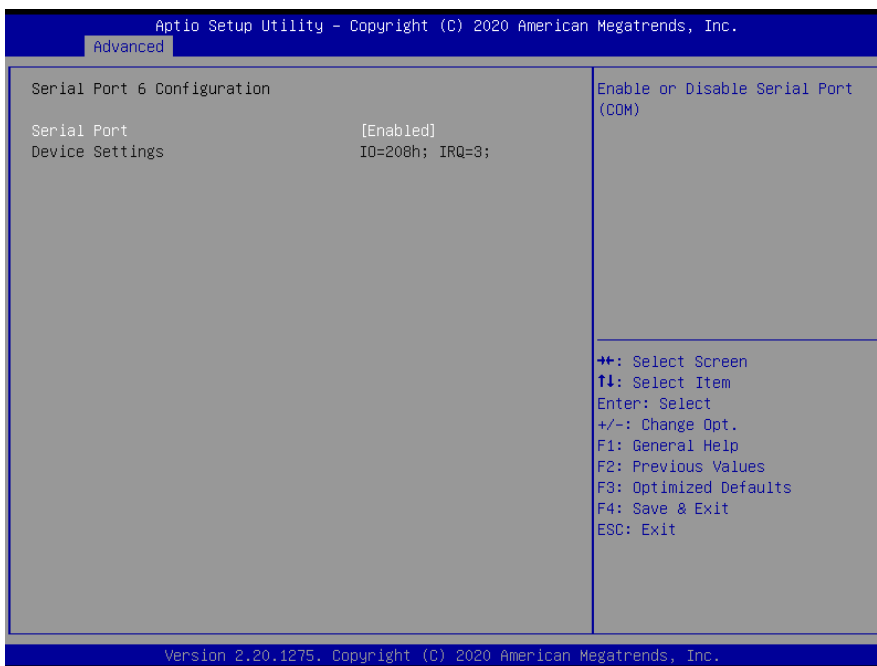

Item	Option	Description
Serial Port	Disabled Enabled[Default],	Enable or Disable Serial Port (COM).

3.6.2.6 NCT6106D H/W Monitor

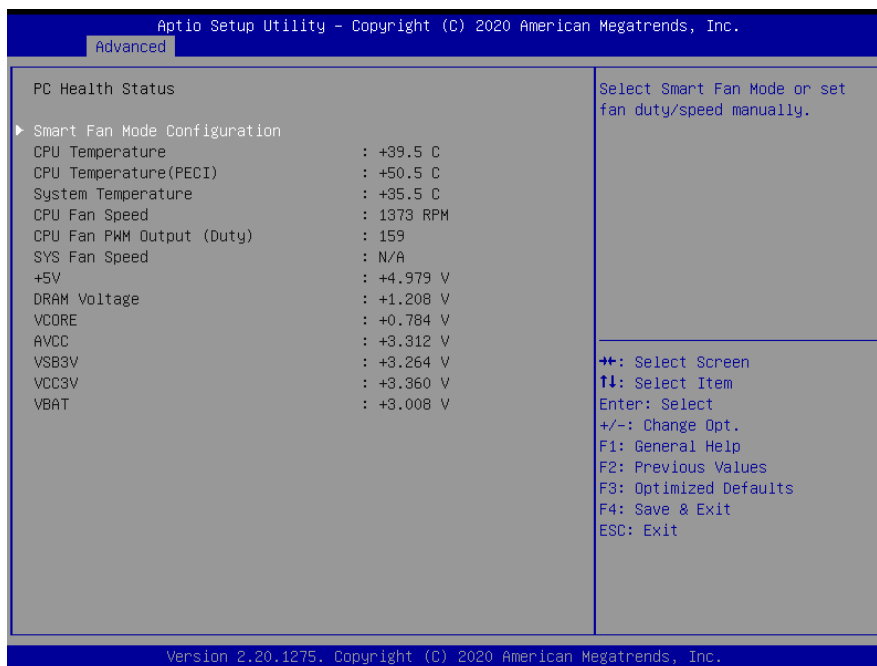

3.6.2.6.1 Smart Fan Configuration

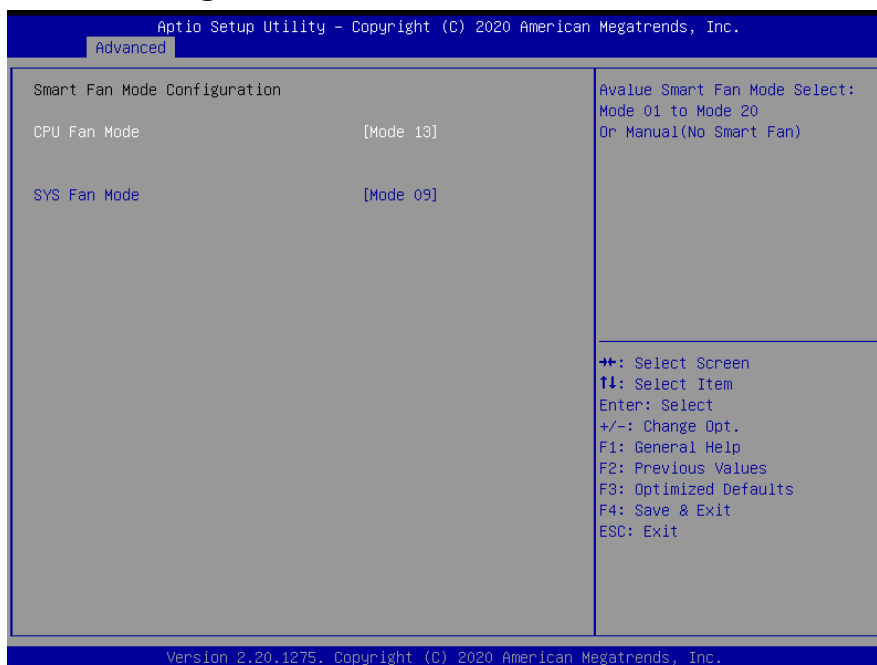

Item	Option	Description
CPU Fan Mode	Manual Mode	Avalue Smart Fan Mode Select: Mode 01 to Mode 20 Or Manual (No Smart Fan)
	Mode 01	
	Mode 02	
	Mode 03	
	Mode 04	

EMX-H310P User's Manual

	<p>Mode 05 Mode 06 Mode 07 Mode 08 Mode 09 Mode 10 Mode 11 Mode 12 Mode 13[Default], Mode 14 Mode 15 Mode 16 Mode 17 Mode 18 Mode 19 Mode 20</p>	
<p>SYS Fan Mode</p>	<p>Manual Mode Mode 01 Mode 02 Mode 03 Mode 04 Mode 05 Mode 06 Mode 07 Mode 08 Mode 09[Default], Mode 10 Mode 11 Mode 12 Mode 13 Mode 14 Mode 15 Mode 16 Mode 17 Mode 18 Mode 19 Mode 20</p>	<p>Avalue Smart Fan Mode Select: Mode 01 to Mode 20 Or Manual (No Smart Fan)</p>

3.6.2.7 S5 RTC Wake Settings

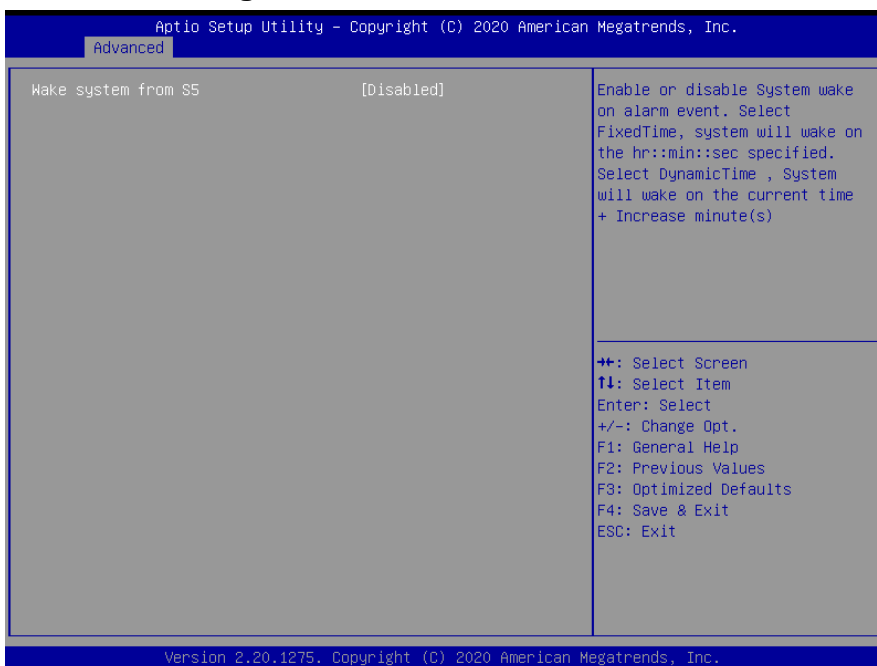

Item	Options	Description
Wake system from S5	Disabled[Default], Fixed Time Dynamic Time	Enable or disable System wake on alarm event. Select FixedTime, system will wake on the hr::min::sec specified. Select DynamicTime, System will wake on the current time + Increase minute(s).

3.6.2.8 Serial Port Console Redirection

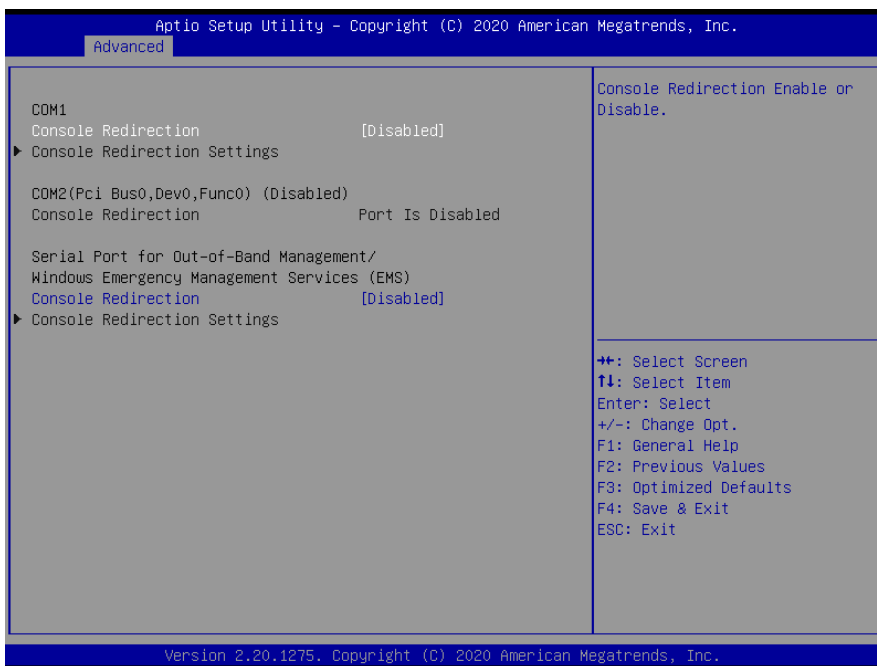

Item	Options	Description
Console Redirection	Disabled[Default], Enabled	Console Redirection Enable or Disable.

3.6.2.9 USB Configuration

The USB Configuration menu helps read USB information and configures USB settings.

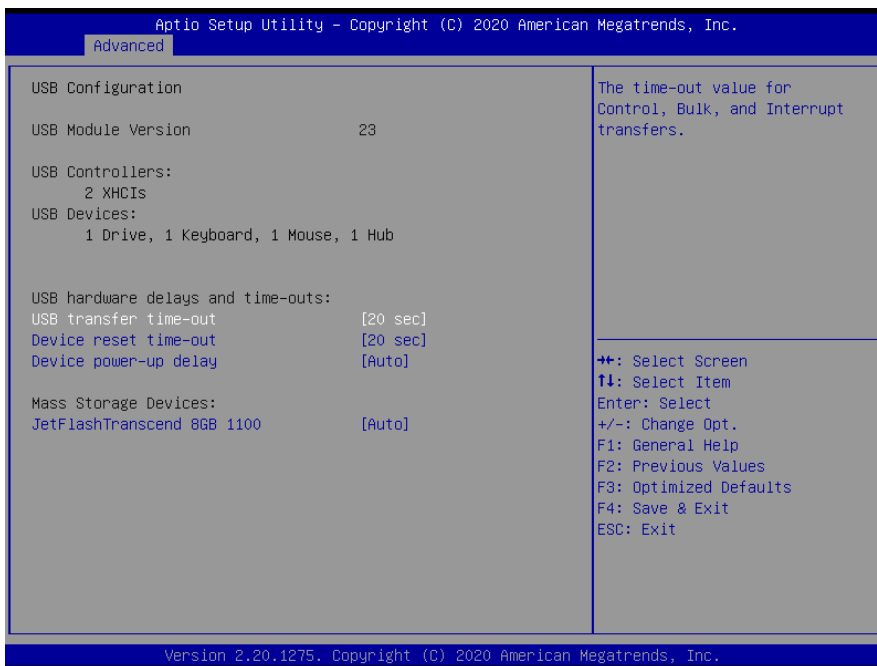

Item	Options	Description
USB transfer time-out	1 sec 5 sec 10 sec 20 sec [Default]	The time-out value for Control, Bulk, and Interrupt transfers.
Device reset time-out	10 sec 20 sec [Default] 30 sec 40 sec	USB mass storage device Start Unit command time-out.
Device power-up delay	Auto [Default] Manual	Maximum time the device will take before it properly reports itself to the Host Controller. 'Auto' uses default value: for a Root port it is 100ms, for a Hub port the delay is taken form Hub descriptor.
JetF lashTranscend 8GB 1100	Auto [Default] Floppy Forced FDD Hard Disk CD-ROM	Mass storage device emulation type. 'AUTO' enumerates devices according to their media format. Optical drives are emulated as 'CDROM' drives with no media will be emulated according to a drive type.

3.6.2.10 Network Stack Configuration



Item	Options	Description
Network Stack	Disabled[Default], Enabled	Enable/Disable UEFI Network Stack.



Note: Motherboard designed with quad Gigabit LAN consumes longer startup time when Network Stack setting at “Enable”, this is a normal phenomenon.

3.6.3 Chipset

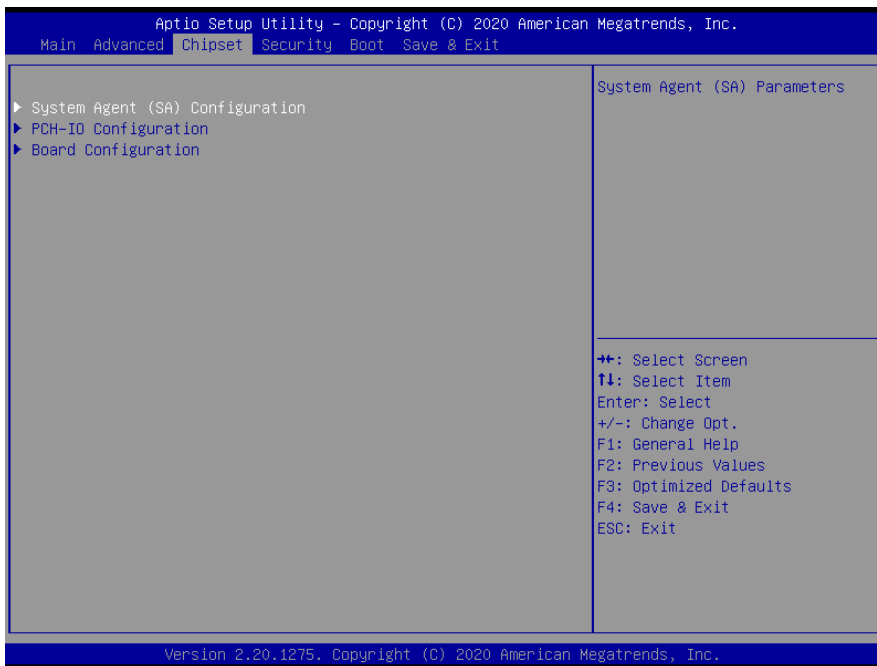

3.6.3.1 System Agent (SA) Configuration

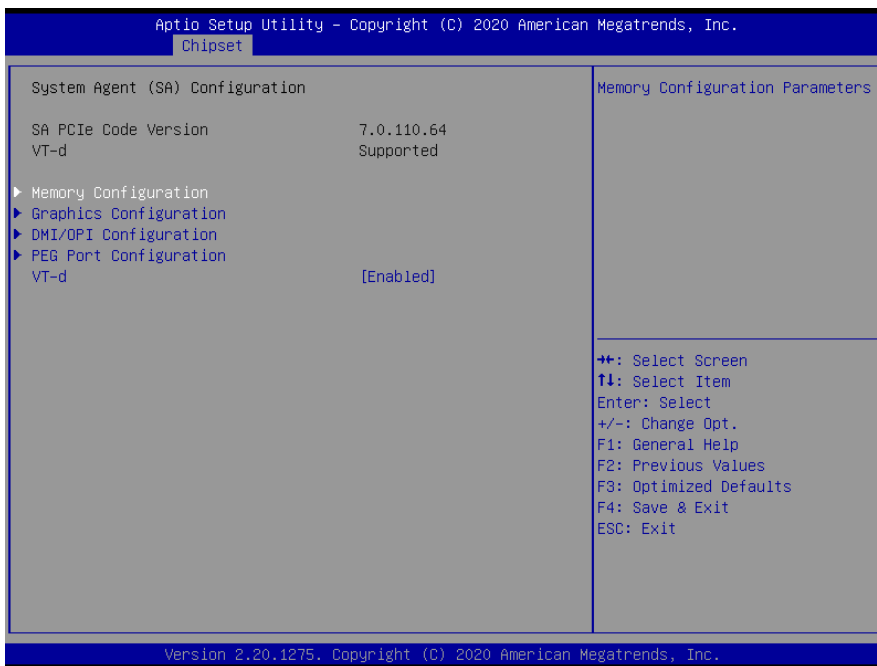

Item	Option	Description
VT-d	Disabled Enabled[Default]	VT-d capability.

3.6.3.1.1 Memory Configuration

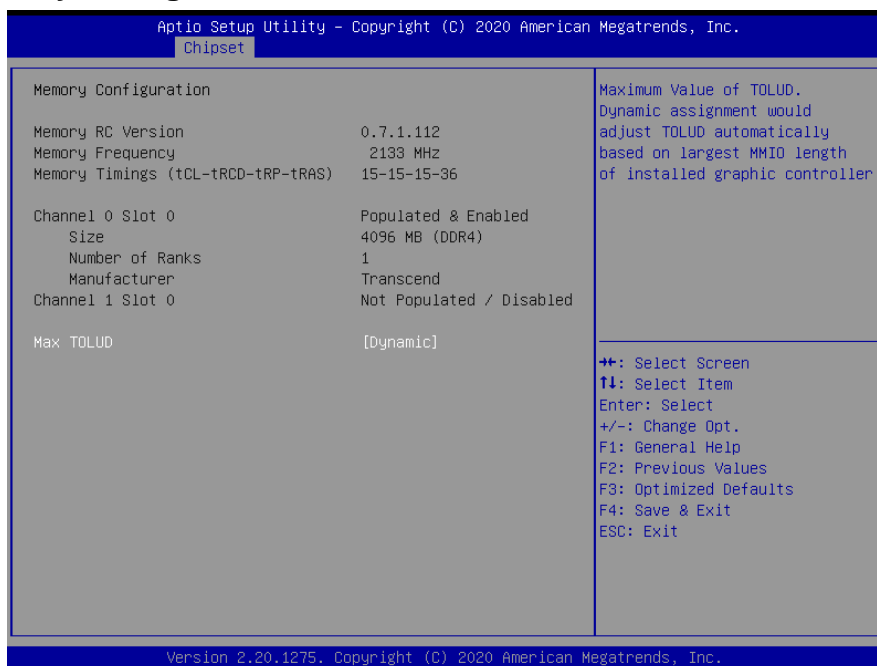

Item	Option	Description
Max TOLUD	Dynamic[Default]	Maximum Value of TOLUD. Dynamic assignment would adjust TOLUD automatically based on largest MMIO length of installed graphic controller
	1GB	
	1.25 GB	
	1.5 GB	
	1.75 GB	
	2 GB	
	2.25 GB	
	2.5 GB	
	2.75 GB	
3 GB		

3.6.3.1.2 Graphics Configuration

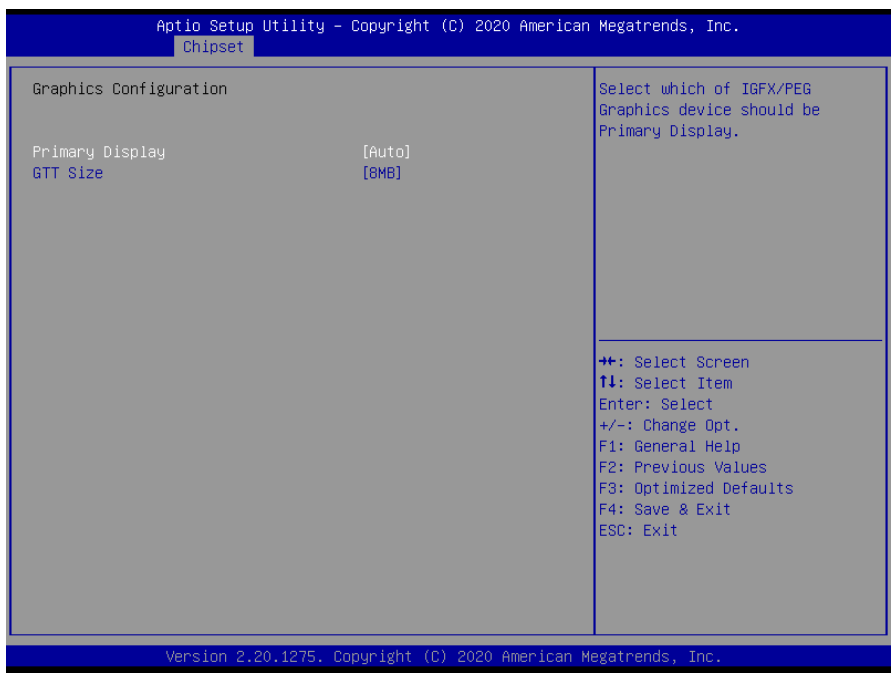

Item	Option	Description
Primary Display	Auto[Default] IGFX PEG	Select which of IGFX/PEG Graphics device should be Primary Display.
GTT Size	2MB 4MB 8MB[Default]	Select the GTT Size

3.6.3.1.3 DMI/OPI Configuration

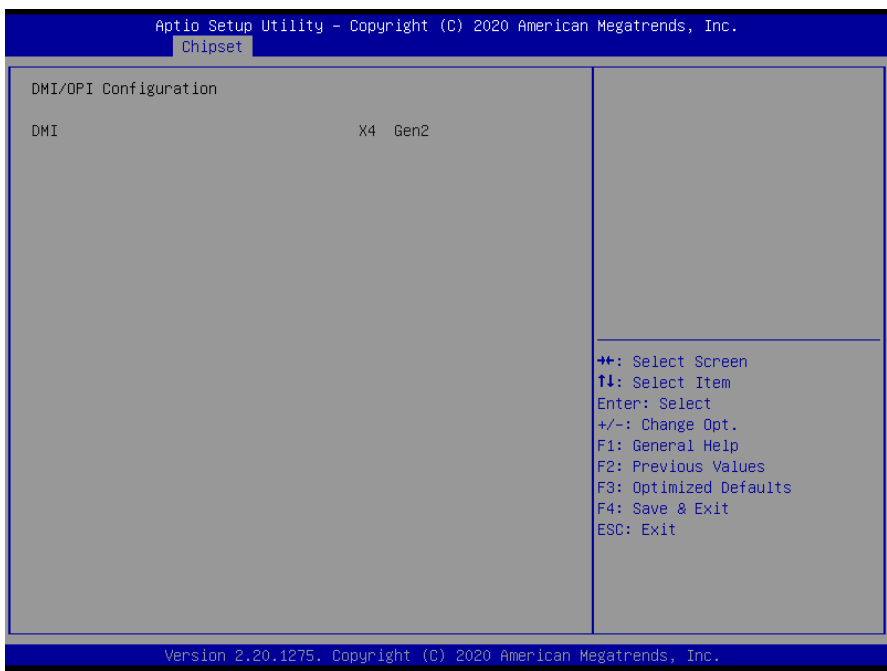

3.6.3.1.4 PEG Port Configuration



Item	Option	Description
Enable Root Port	Disabled Enabled Auto[Default]	Enable or Disable the Root Port.
Max Link Speed	Auto[Default] Gen1 Gen2 Gen3	Configure PEG 0:1:0 Max Speed
Max Link Width	Auto[Default] Force X1 Force X2 Force X4 Force X8	Force PEG link to retrain to X1/2/4/8
ASPM	Disabled[Default] Auto ASPM L0s ASPM L1 ASPM L0sL1	Control ASPM support for the PEG 0. This has no effect if PEG is not the currently active device.
PEG0 (PCIEX1) Max Payload size	Auto[Default] 128 256 TLP	Select PEG0 Max Payload size; Choose Auto(Default Device Capability) or force to 128/256 Bytes
Program PCIe ASPM after OpROM	Disabled[Default] Enabled	Enabled: PCIe ASPM will be programmed after OpROM. Disabled: PCIe ASPM will be programmed before OpROM.

3.6.3.1.4.1 PEG Port Feature Configuration

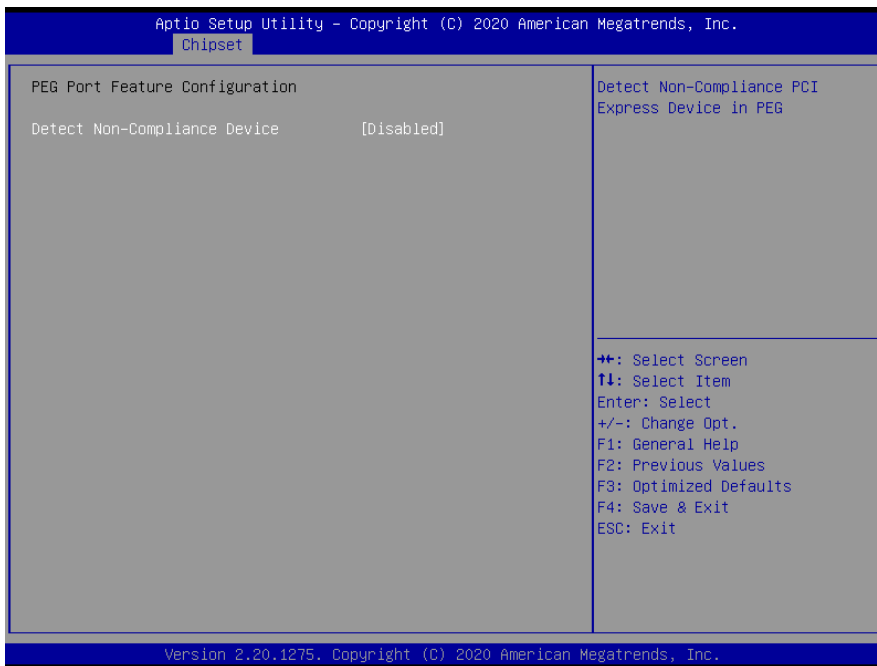

Item	Option	Description
Detect Non-Compliance Device	Disabled[Default] Enabled	Detect Non-Compliance PCI Express Device in PEG

3.6.3.2 PCH-IO Configuration

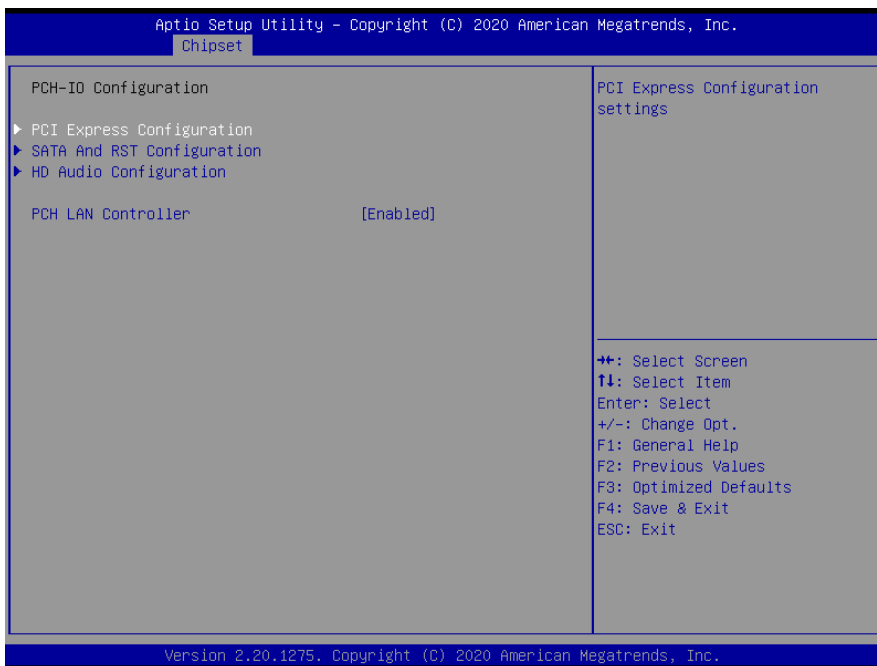

Item	Option	Description
PCH LAN Controller	Enabled[Default] Disabled	Enable/Disable onboard NIC.

3.6.3.2.1 PCI Express Configuration

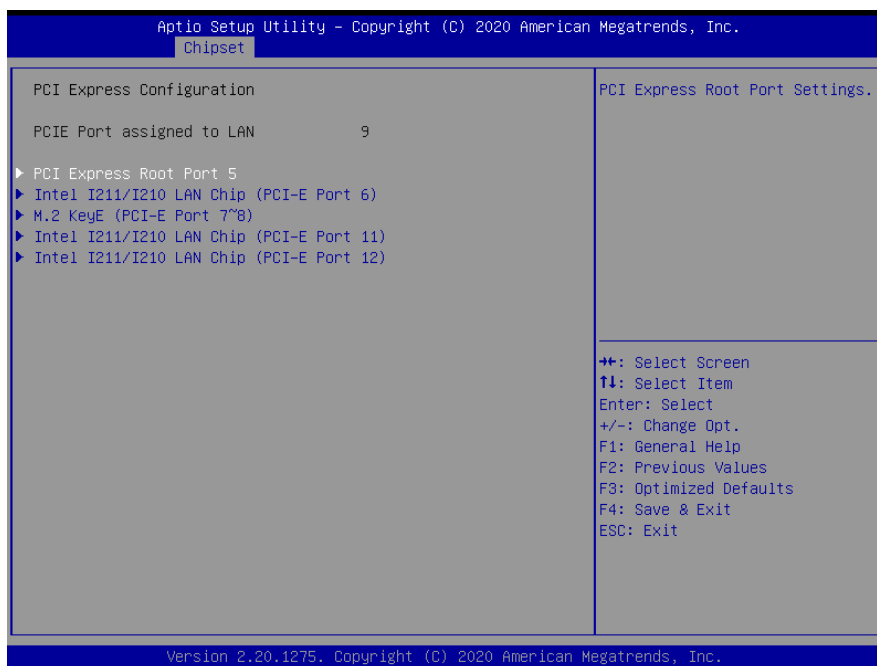

3.6.3.2.1.1 PCI Express Root Port 5

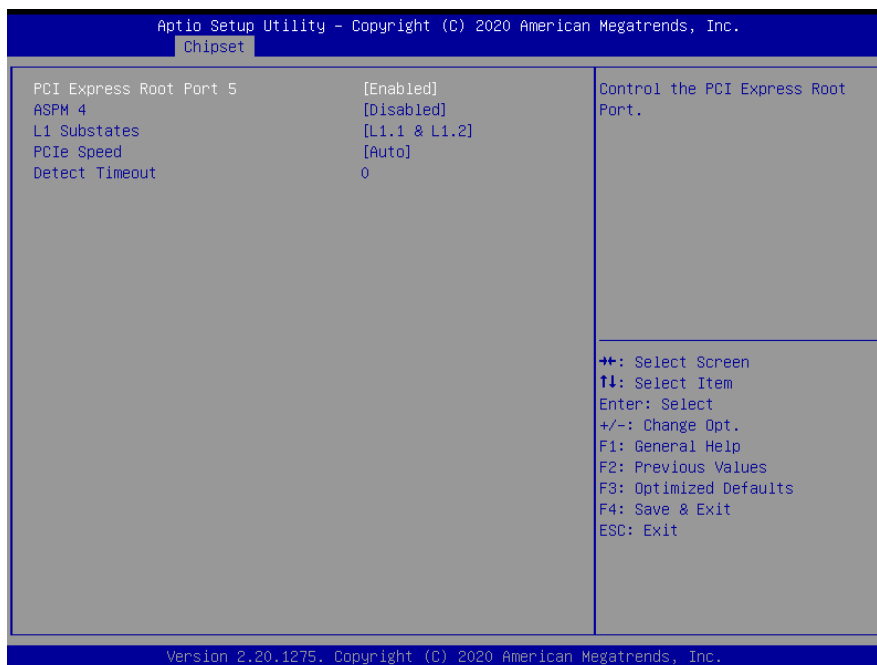

Item	Option	Description
PCI Express Root Port 5	Disabled Enabled[Default],	Control the PCI Express Root Port.
ASPM 4	Disabled[Default] L0s L1	Set the ASPM Level: Force L0s - Force all links to L0s State AUTO - BIOS auto configure DISABLE - Disables ASPM.

EMX-H310P User's Manual

	L0sL1 Auto	
L1 Substates	Disabled L1.1 L1.1 & L1.2[Default]	PCI Express L1 Substates settings.
PCIe Speed	Auto[Default] Gen1 Gen2 Gen3	Configure PCIe Speed
Detect Timeout	0	The number of milliseconds reference code will wait for link to exit Detect state for enabled ports before assuming there is no device and potentially disabling the port.

3.6.3.2.1.2 Intel I211/I210 LAN Chip (PCI-E Port 6)

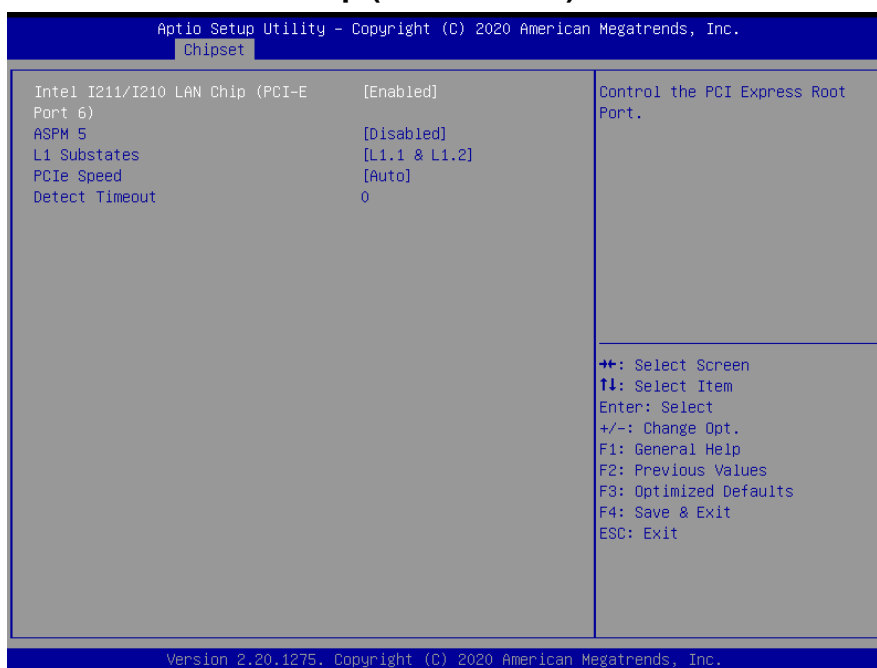

Item	Option	Description
Intel I211/I210 LAN Chip (PCI-E Port 6)	Disabled Enabled[Default],	Control the PCI Express Root Port.
ASPM 5	Disabled[Default] L0s L1 L0sL1 Auto	Set the ASPM Level: Force L0s - Force all links to L0s State AUTO - BIOS auto configure DISABLE - Disables ASPM.
L1 Substates	Disabled L1.1 L1.1 & L1.2[Default]	PCI Express L1 Substates settings.
PCIe Speed	Auto[Default] Gen1 Gen2 Gen3	Configure PCIe Speed

<p>Detect Timeout</p>	<p>0</p>	<p>The number of milliseconds reference code will wait for link to exit Detect state for enabled ports before assuming there is no device and potentially disabling the port.</p>
------------------------------	----------	---

3.6.3.2.1.3 M.2 KeyE (PCI-E Port 7~8)

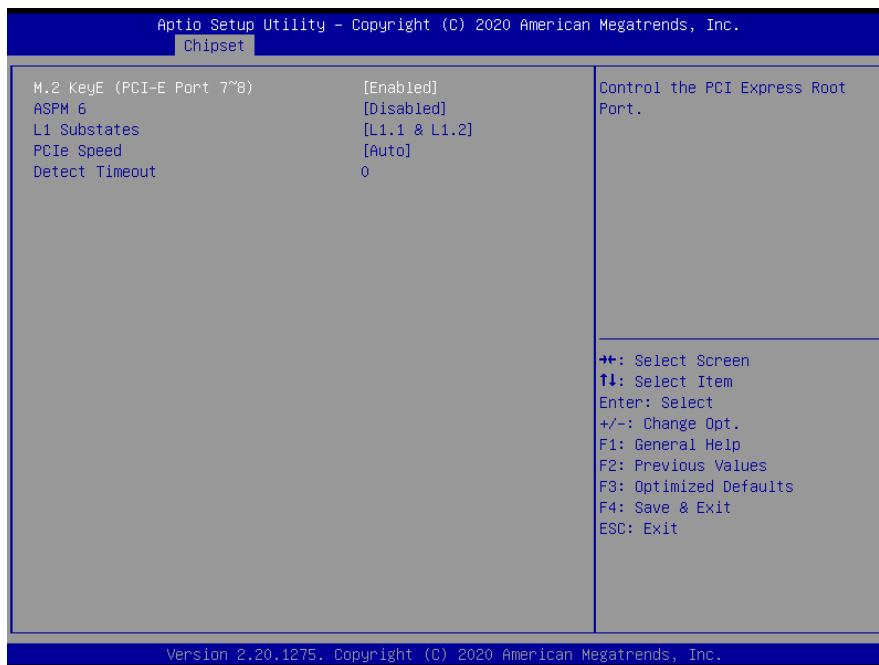

Item	Option	Description
<p>M.2 KeyE (PCI-E Port 7~8)</p>	<p>Disabled Enabled[Default],</p>	<p>Control the PCI Express Root Port.</p>
<p>ASPM 6</p>	<p>Disabled[Default] L0s L1 L0sL1 Auto</p>	<p>Set the ASPM Level: Force L0s - Force all links to L0s State AUTO - BIOS auto configure DISABLE - Disables ASPM.</p>
<p>L1 Substates</p>	<p>Disabled L1.1 L1.1 & L1.2[Default]</p>	<p>PCI Express L1 Substates settings.</p>
<p>PCIe Speed</p>	<p>Auto[Default] Gen1 Gen2 Gen3</p>	<p>Configure PCIe Speed</p>
<p>Detect Timeout</p>	<p>0</p>	<p>The number of milliseconds reference code will wait for link to exit Detect state for enabled ports before assuming there is no device and potentially disabling the port.</p>

3.6.3.2.1.4 Intel I211/I210 LAN Chip (PCI-E Port 11)

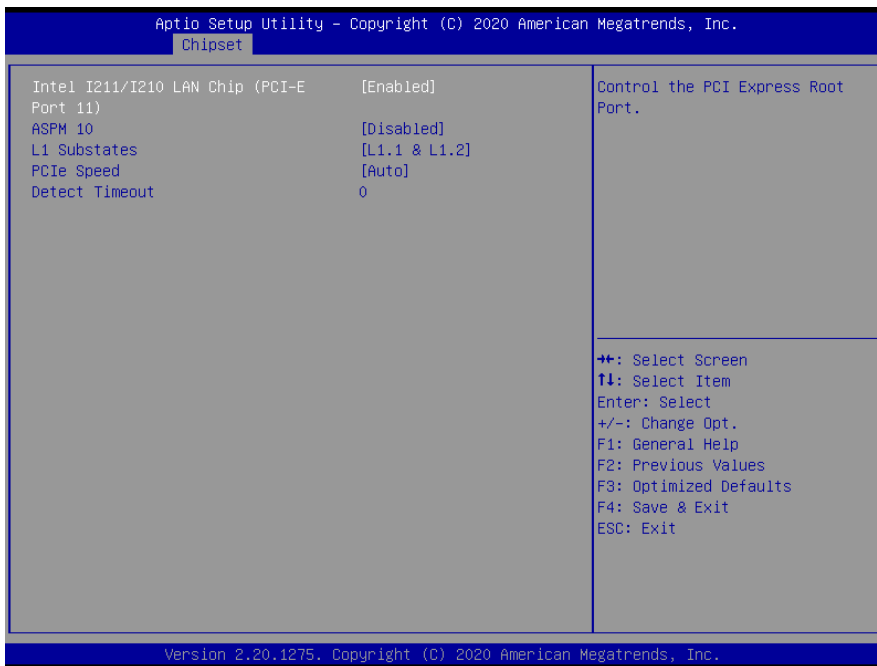

Item	Option	Description
Intel I211/I210 LAN Chip (PCI-E Port 11)	Disabled Enabled[Default],	Control the PCI Express Root Port.
ASPM 10	Disabled[Default] L0s L1 L0sL1 Auto	Set the ASPM Level: Force L0s - Force all links to L0s State AUTO - BIOS auto configure DISABLE - Disables ASPM.
L1 Substates	Disabled L1.1 L1.1 & L1.2[Default]	PCI Express L1 Substates settings.
PCIe Speed	Auto[Default] Gen1 Gen2 Gen3	Configure PCIe Speed
Detect Timeout	0	The number of milliseconds reference code will wait for link to exit Detect state for enabled ports before assuming there is no device and potentially disabling the port.

3.6.3.2.1.5 Intel I211/I210 LAN Chip (PCI-E Port 12)

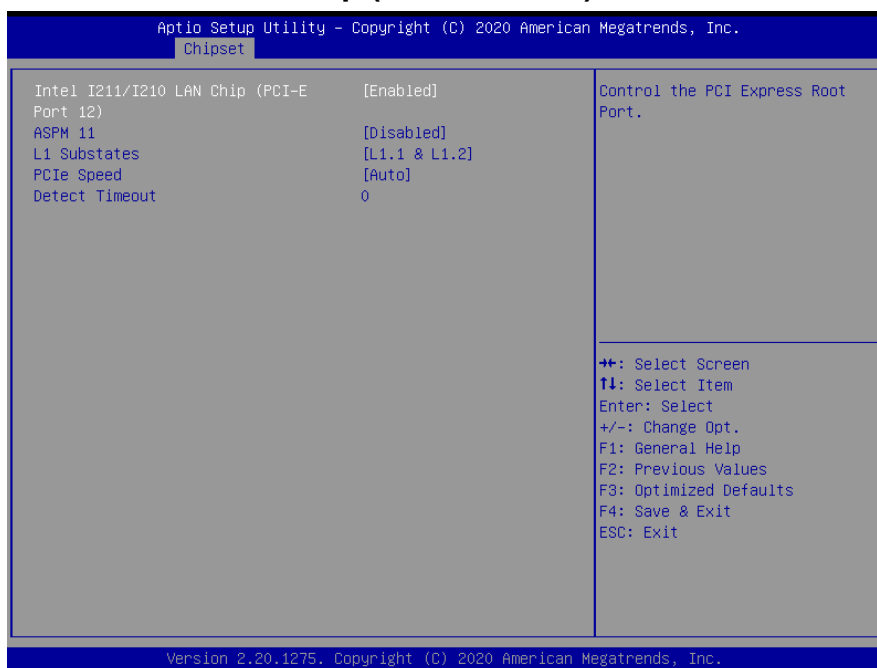

Item	Option	Description
Intel I211/I210 LAN Chip (PCI-E Port 11)	Disabled Enabled[Default],	Control the PCI Express Root Port.
ASPM 11	Disabled[Default] L0s L1 L0sL1 Auto	Set the ASPM Level: Force L0s - Force all links to L0s State AUTO - BIOS auto configure DISABLE - Disables ASPM.
L1 Substates	Disabled L1.1 L1.1 & L1.2[Default]	PCI Express L1 Substates settings.
PCIe Speed	Auto[Default] Gen1 Gen2 Gen3	Configure PCIe Speed
Detect Timeout	0	The number of milliseconds reference code will wait for link to exit Detect state for enabled ports before assuming there is no device and potentially disabling the port.

3.6.3.2.2 SATA And RST Configuration

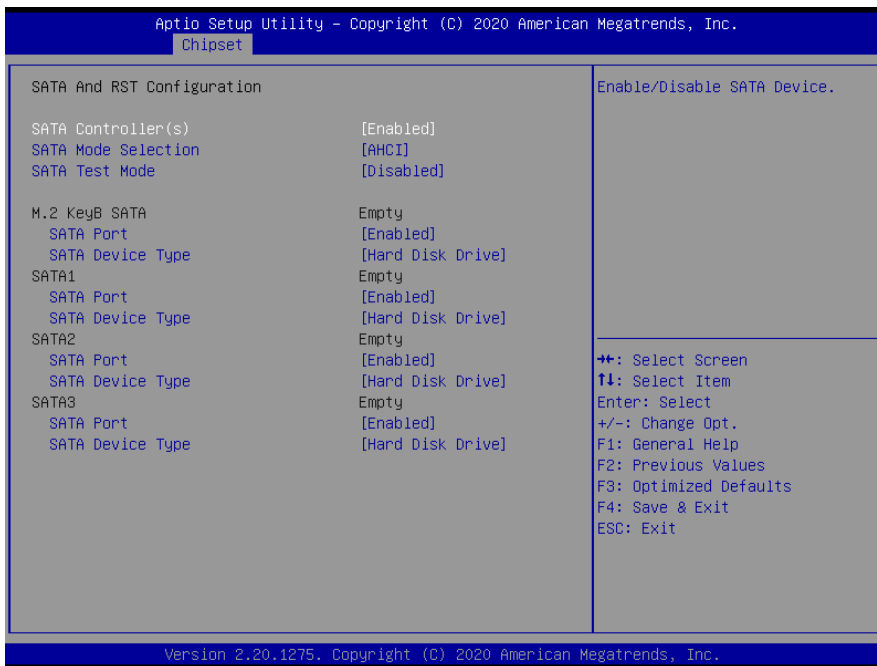

Item	Options	Description
SATA Configuration(S)	Enabled[Default], Disabled	Enable/Disable SATA Device.
SATA Mode Selection	AHCI[Default], RAID	Determines how SATA controller(s) operate.
SATA Test Mode	Enabled Disabled[Default],	Test Mode Enable/Disable (Loop Back).
SATA Port	Disabled Enabled[Default],	Enable or Disable SATA Port
SATA Device Type	Hard Disk Drive[Default], Solid State Drive	Identify the SATA port is connected to Solid State Drive or Hard Disk Drive.

3.6.3.2.3 HD Audio Configuration



Item	Option	Description
HD Audio	Disabled Enabled[Default],	Control Detection of the HD-Audio device. Disabled = HDA will be unconditionally disabled Enabled = HDA will be unconditionally enabled.

3.6.3.3 Board Configuration

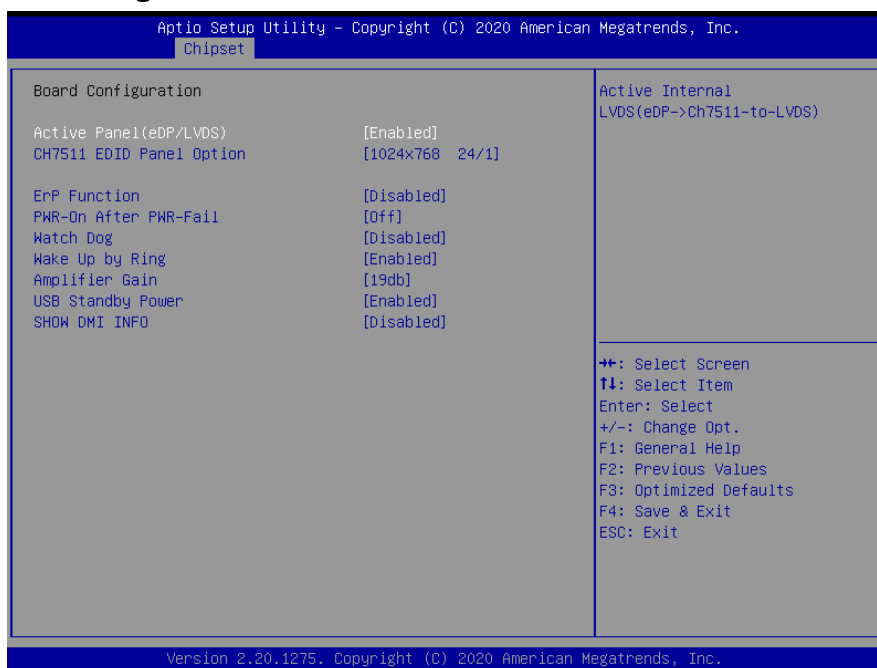

Item	Option	Description
Active Panel (eDP/LVDS)	Disabled Enabled[Default],	Active Internal LVDS(eDP->Ch7511-to-LVDS)

EMX-H310P User's Manual

CH7511 EDID Panel Option	1024x768 24/1[Default], 800x600 18/1 1024x768 18/1 1366x768 18/1 1024x600 18/1 1280x800 18/1 1920x1200 24/2 1920x1080 18/2 1280x1024 24/2 1440x900 18/2 1600x1200 24/2 1366x768 24/1 1920x1080 24/2 1680x1050 24/2	Port1-EDP to LVDS(Chrotel 7511) Panel EDID Option
ErP Function	Disabled[Default], Enabled	ErP Function (Deep S5).
PWR-On After PWR-Fail	Off[Default], On Last state	AC loss resume.
Watch Dog	Disabled[Default], 30 sec 40 sec 50 sec 1 min 2 min 10 min 30 min	Select WatchDog.
Wake Up by Ring	Disabled Enabled[Default],	Wake Up by Ring from S3/S4/S5
Amplifier Gain	11db 14db 19db[Default], 25db	Amplifier Gain
USB Standby Power	Disabled Enabled[Default],	Enabled/Disabled USB Standby Power during S3/S4/S5
SHOW DMI INFO	Disabled[Default], Enabled	SHOW DMI INFO

3.6.4 Security

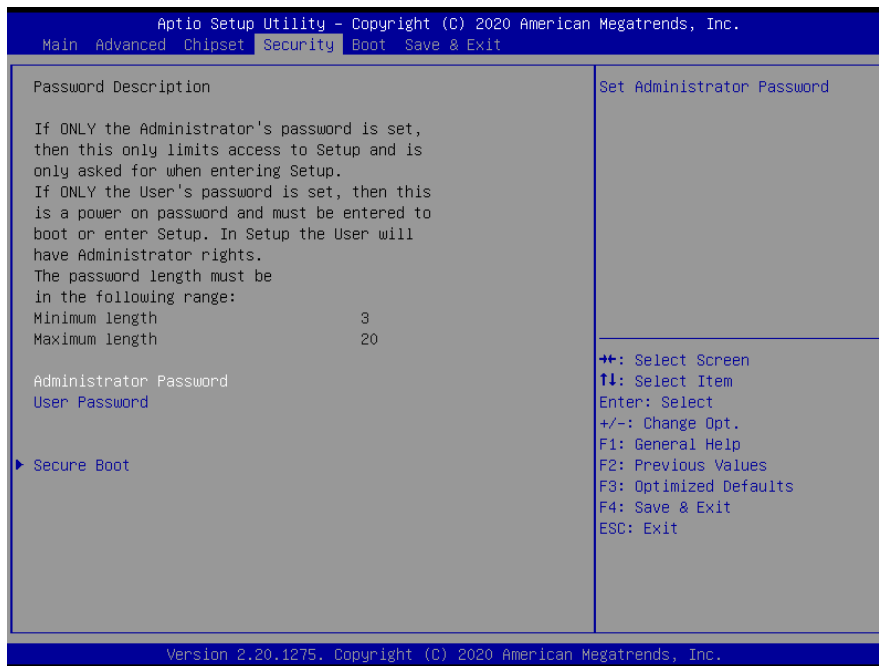

Item	Description
Administrator Password	Set Administrator Password
User Password	Set User Password

3.6.4.1 Secure Boot



EMX-H310P User's Manual

Item	Option	Description
Secure Boot	Disabled[Default], Enabled	Secure Boot feature is Active if Secure Boot is Enabled, Platform Key(PK) is enrolled and the System is in User mode. The mode change requires platform reset
Secure Boot Mode	Standard Custom[Default],	Secure Boot mode options: Standard or Custom. In Custom mode, Secure Boot Policy variables can be configured by a physically present user without full authentication

3.6.4.1.1 Restore Factory Keys

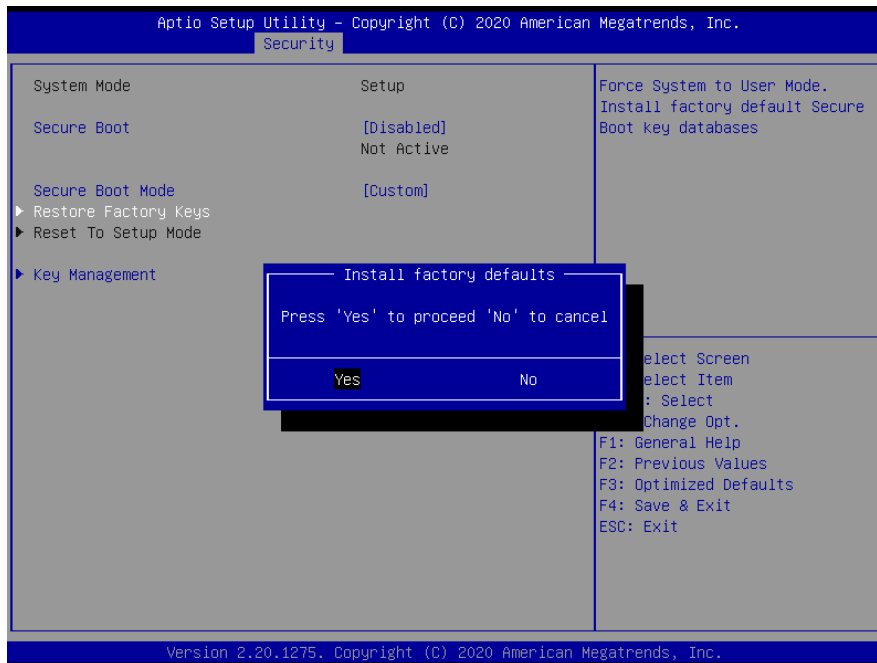

3.6.4.1.2 Key Management

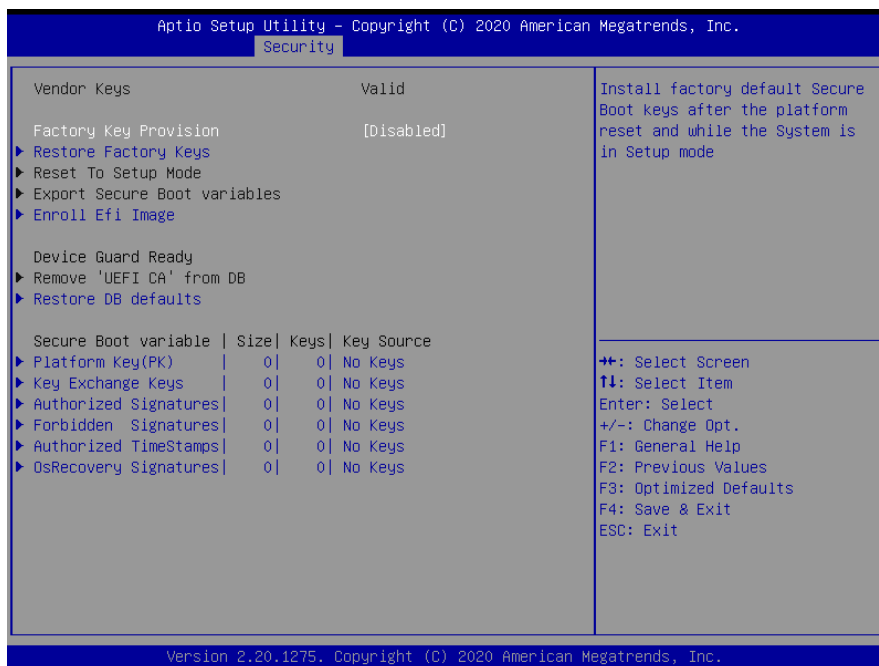

3.6.5 Boot

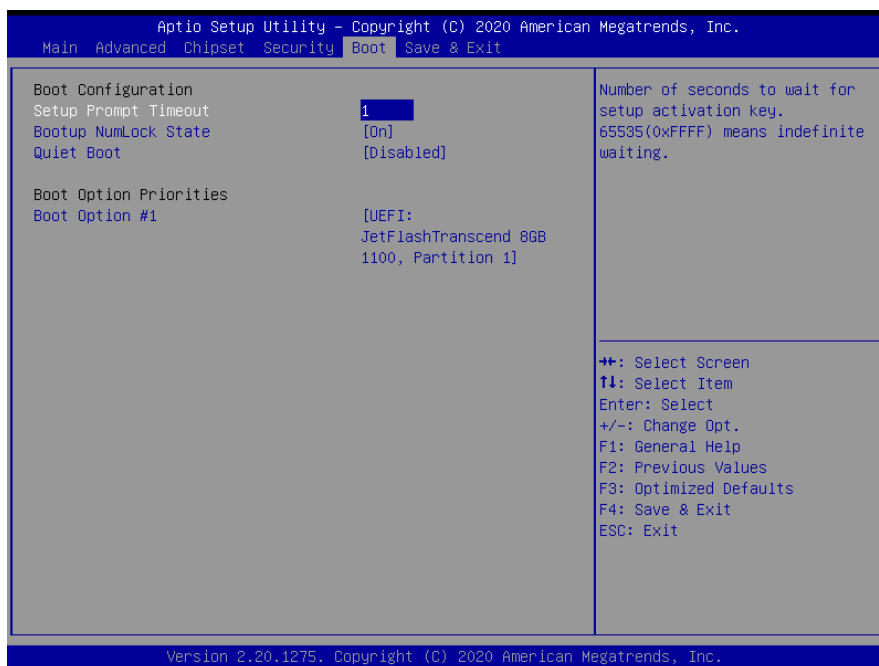

Item	Option	Description
Setup Prompt Timeout	1	Number of seconds to wait for setup activation key. 65535(0xFFFF) means indefinite waiting.
Bootup NumLock State	On[Default] Off	Select the keyboard NumLock state.
Quiet Boot	Disabled[Default]	Enable or disable Quiet Boot option.

EMX-H310P User's Manual

	Enabled	
Boot Option #1	Sets the system boot order	

3.6.6 Save & Exit

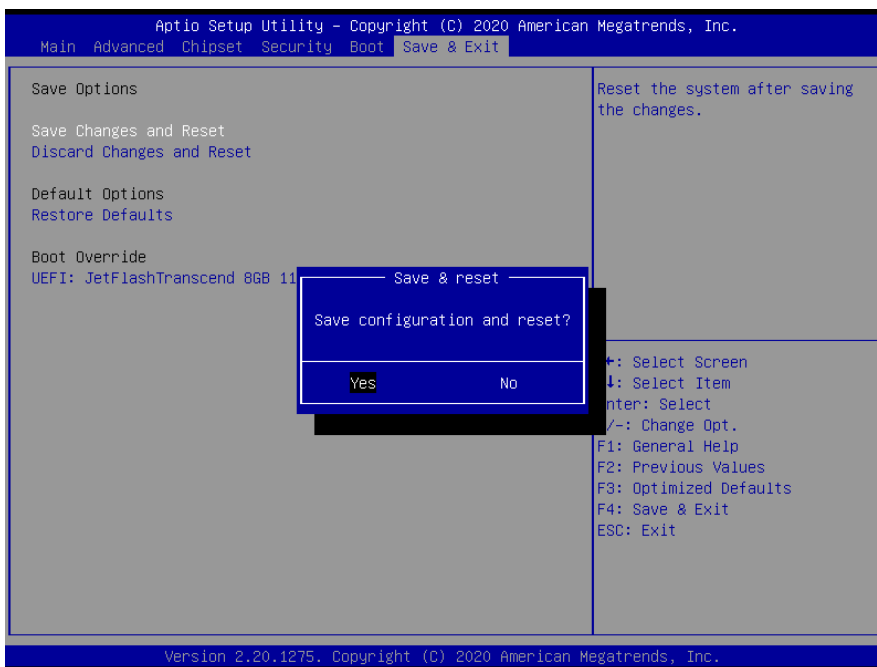
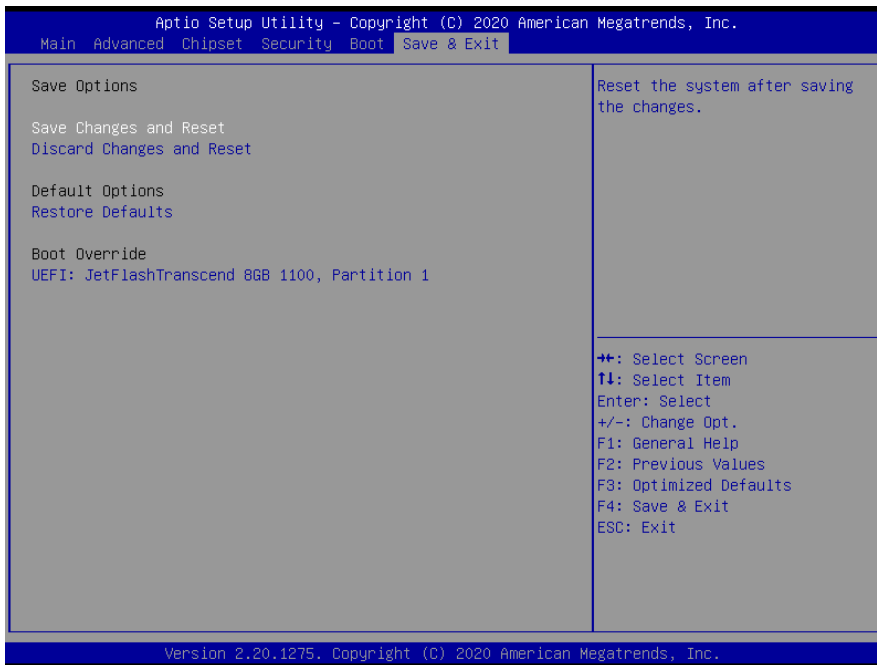

3.6.6.1 Save Changes and Reset

Reset the system after saving the changes.

3.6.6.2 *Discard Changes and Reset*

Any changes made to BIOS settings during this session of the BIOS setup program are discarded. The setup program then exits and reboots the controller.

3.6.6.3 *Restore Defaults*

This option restores all BIOS settings to the factory default. This option is useful if the controller exhibits unpredictable behavior due to an incorrect or inappropriate BIOS setting.

3.6.6.4 *Launch EFI Shell from filesystem device*

Attempts to Launch EFI Shell application (Shellx64.efi) from one of the available filesystem devices.

4. Drivers Installation



Note: Installation procedures and screen shots in this section are for your reference and may not be exactly the same as shown on your screen.

4.1 Install Chipset Driver

All drivers can be found on the Avalue Official Website:

<http://www.avalue.com.tw>.



Note: The installation procedures and screen shots in this section are based on Windows 10 operation system. If the warning message appears while the installation process, click Continue to go on.

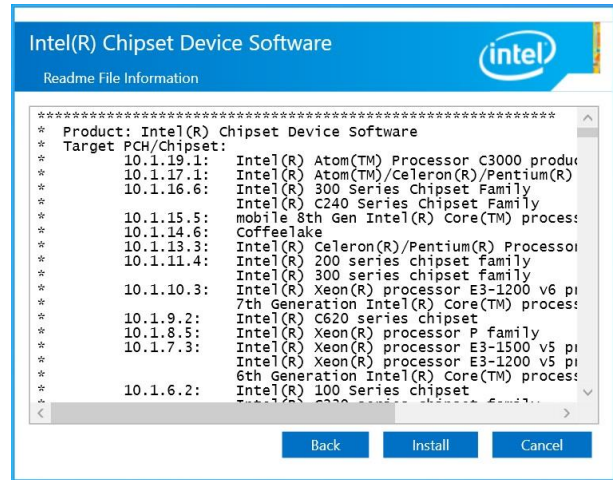

Step 3. Click Install.

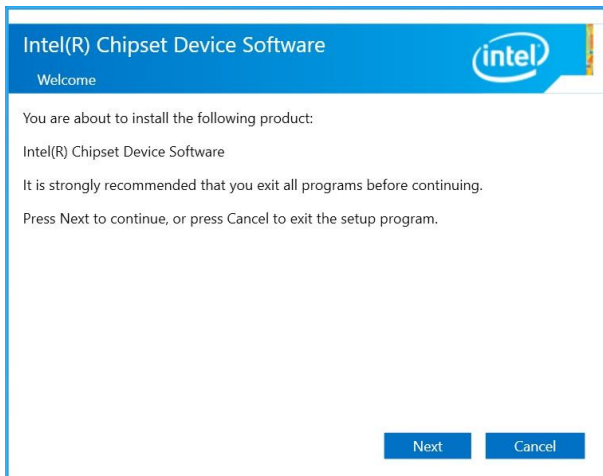

Step1. Click Next.



Step 4. Complete setup.

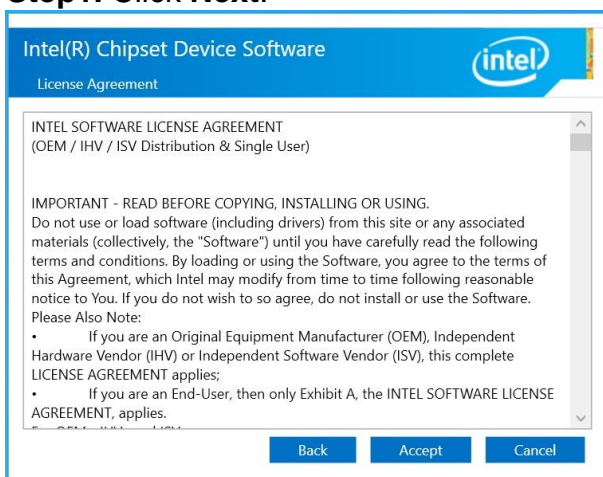

Step 2. Click Accept.

4.2 Install VGA Driver

All drivers can be found on the Avalue Official Website:

<http://www.avalue.com.tw>.



Note: The installation procedures and screen shots in this section are based on Windows 10 operation system. If the warning message appears while the installation process, click Continue to go on.

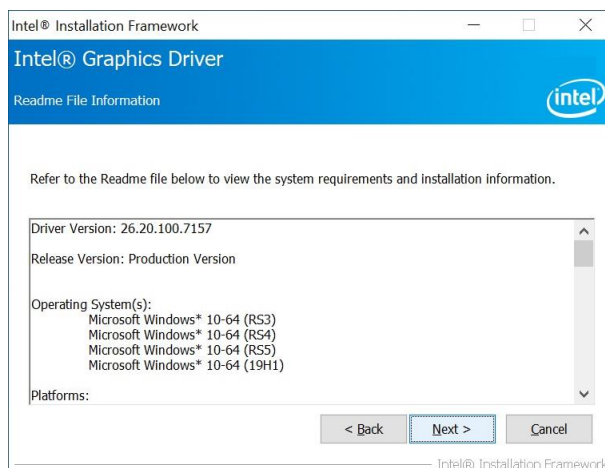

Step 3. Click Next.

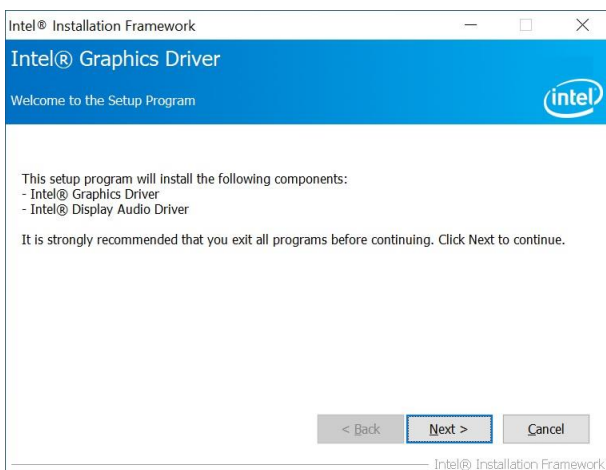

Step 1. Click Next to continue installation.

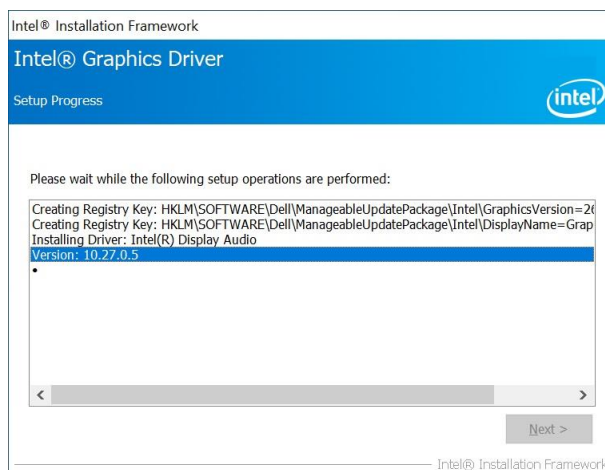

Step 4. Click Next.

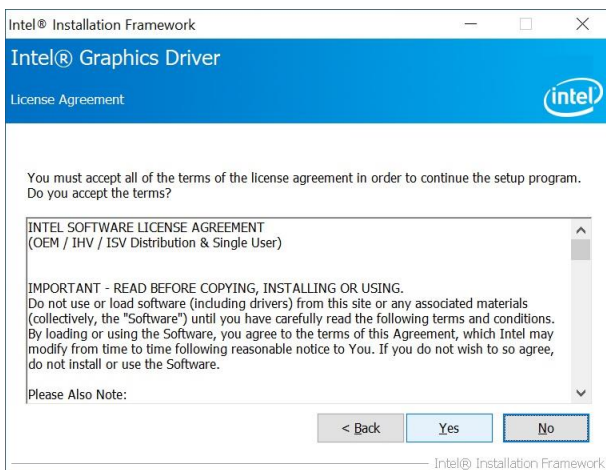

Step 2. Click Yes.

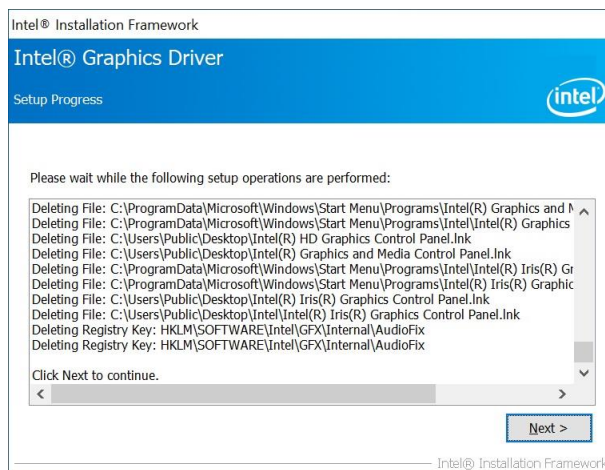

Step 5. Click Next.

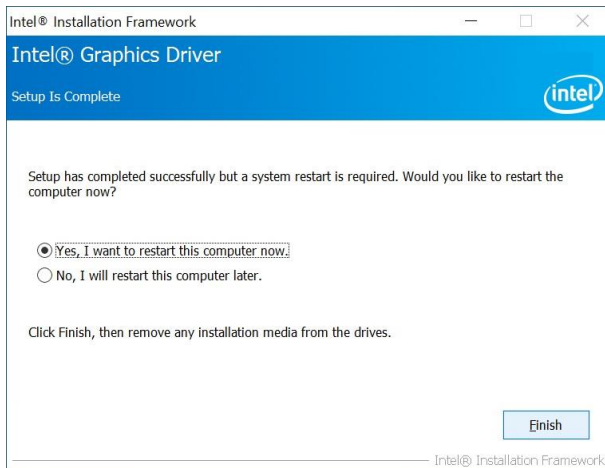

Step 6. Click **Finish** to complete setup.

SUPPORTED PRODUCTS:

The Intel® Graphics Driver contains support for the following Intel Chipsets/Processors with the following graphic support: Intel®, Iris® Pro and Intel® HD graphics:

- 6th Gen Intel® Core™ processor family (codename Skylake) (Workstation-Xeon)

4.3 Install ME Driver

All drivers can be found on the Avalue Official Website:

<http://www.avalue.com.tw>.



Note: The installation procedures and screen shots in this section are based on Windows 10 operation system. If the warning message appears while the installation process, click Continue to go on.

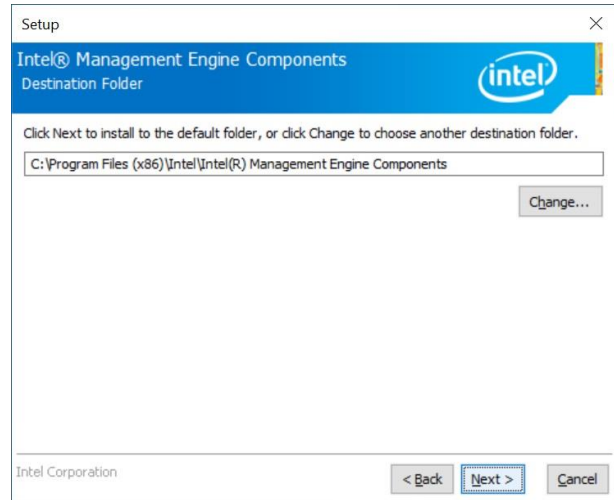

Step 3. Click Next

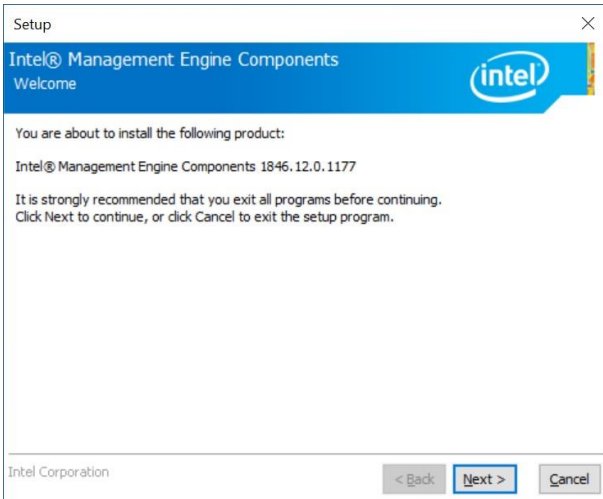

Step 1. Click Next to continue setup.

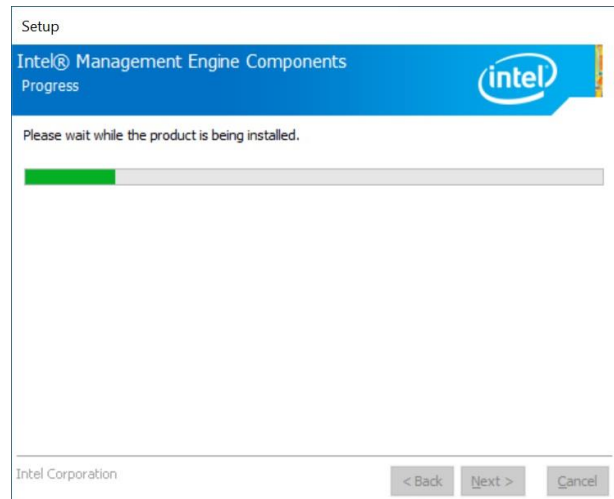

Step 4. Click Next

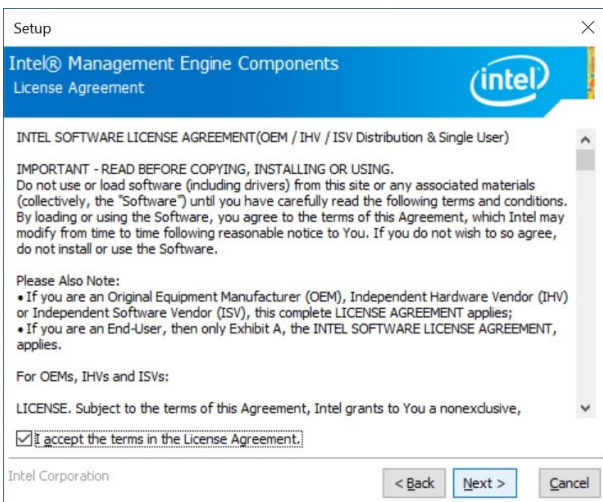

Step 2. Click Next.

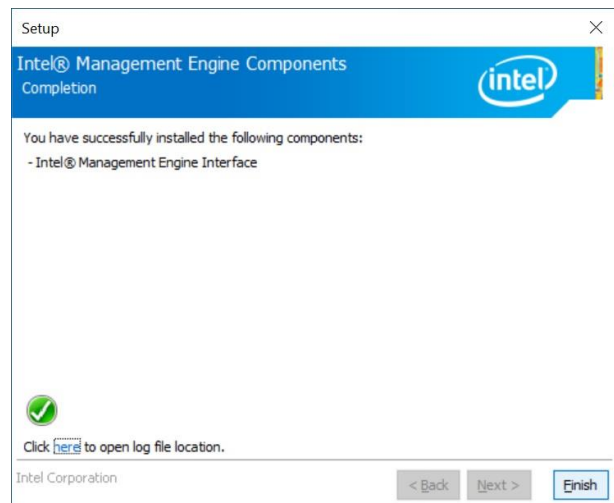

Step 5. Click Finish to complete the setup

4.4 Install Audio Driver

All drivers can be found on the Avalue Official Website:

<http://www.avalue.com.tw>.



Note: The installation procedures and screen shots in this section are based on Windows 10 operation system.

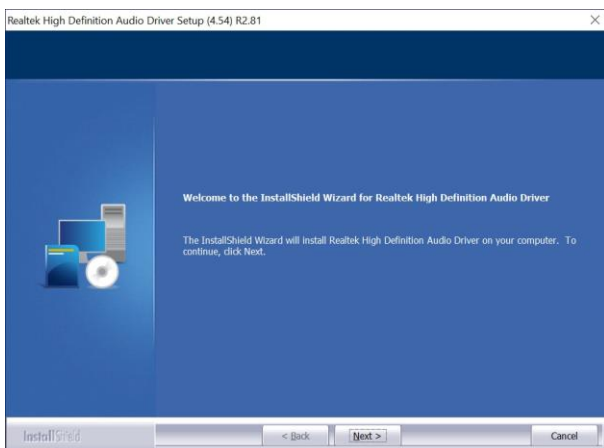

Step1. Click **Next** to Install.

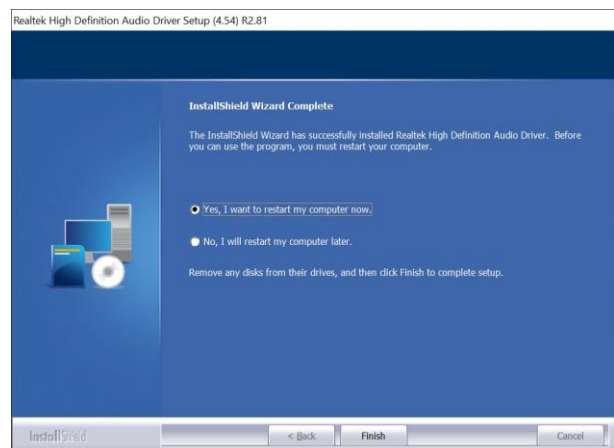

Step 3. Select **Finish** to complete Installation.

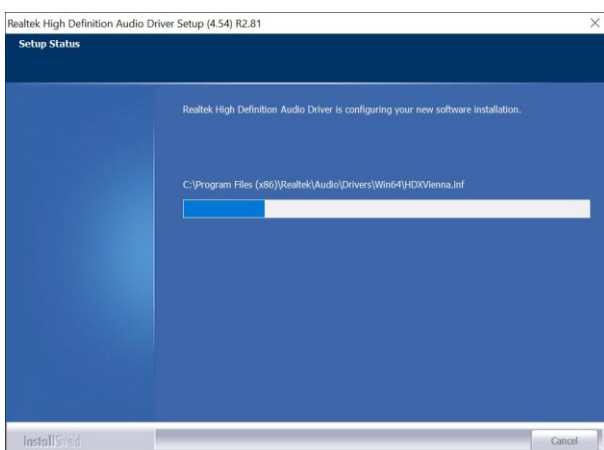

Step 2. Click **Next**.

4.5 Install LAN Driver

All drivers can be found on the Avalue Official Website:

<http://www.avalu.com.tw>.



Note: The installation procedures and screen shots in this section are based on Windows 10 operation system.

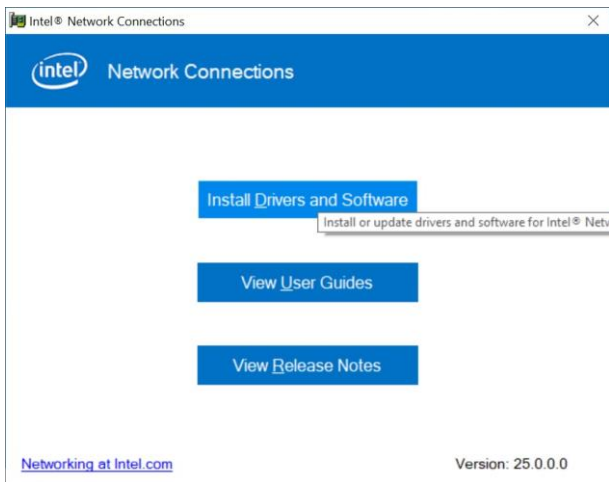

Step 1. Click Install Drivers and Software

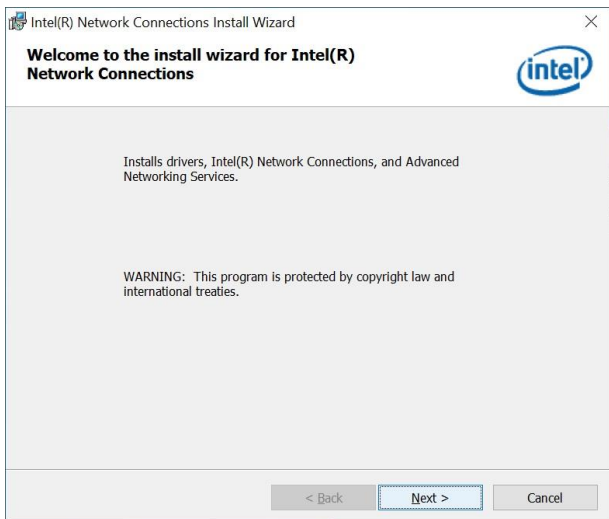

Step 2. Click Next to continue installation.

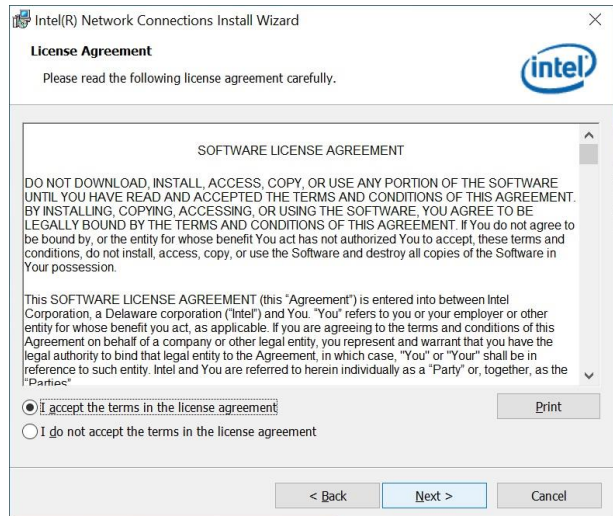

Step 3. Click Next.

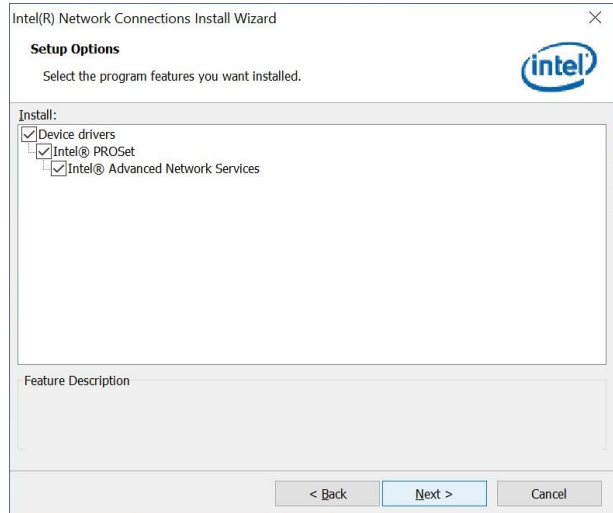

Step 4. Click Next.

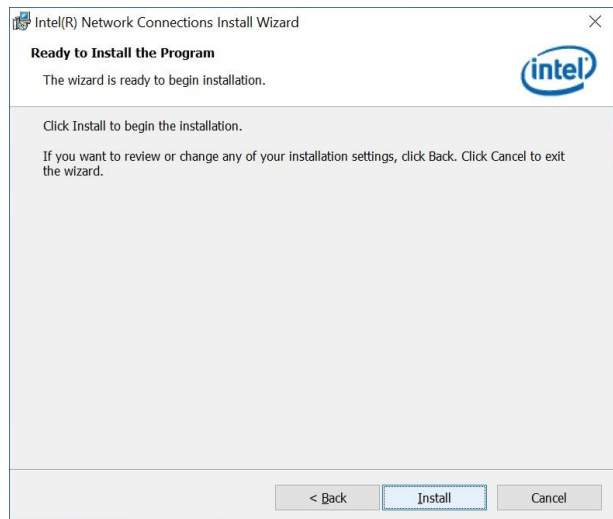

Step 5. Click Install.

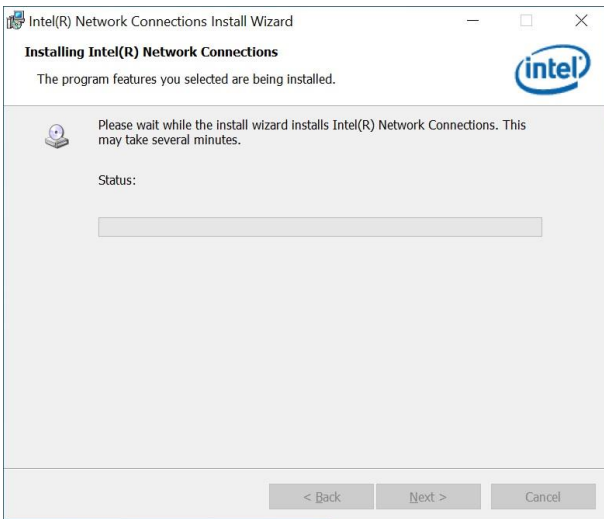

Step 6. Click Next.

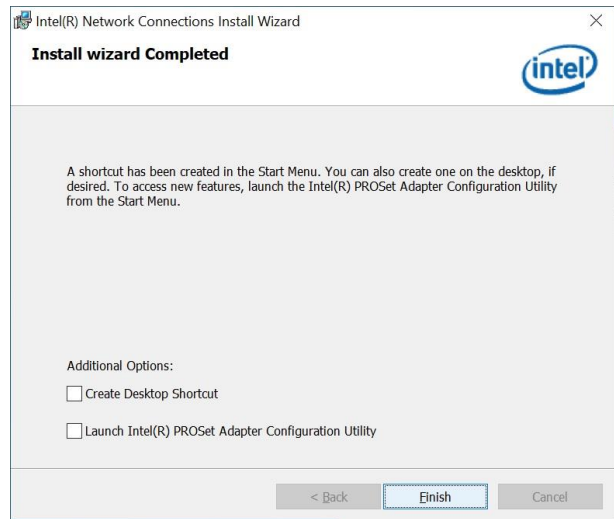

Step 7. Click Finish to complete setup.

4.6 Install RST Driver

All drivers can be found on the Avalue Official Website:

<http://www.avalue.com.tw>.



Note: The installation procedures and screen shots in this section are based on Windows 10 operation system.

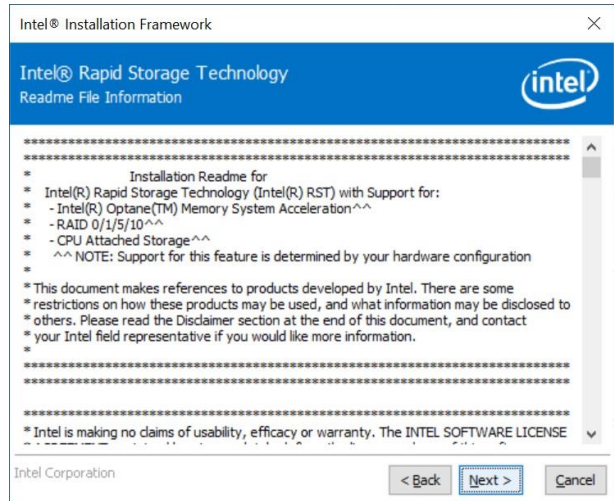

Step 3. Click Next.

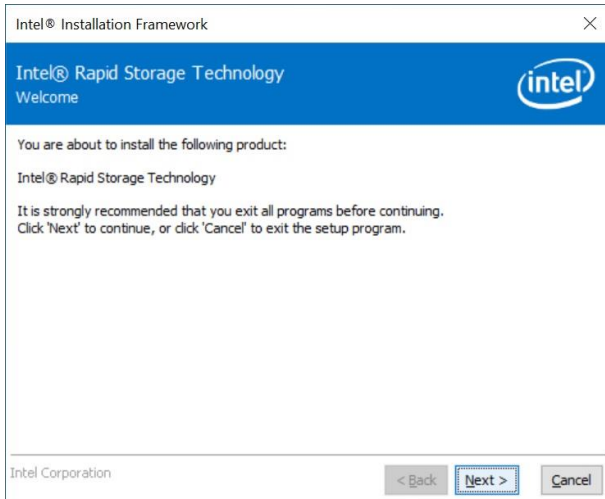

Step 1. Click Next to continue installation.

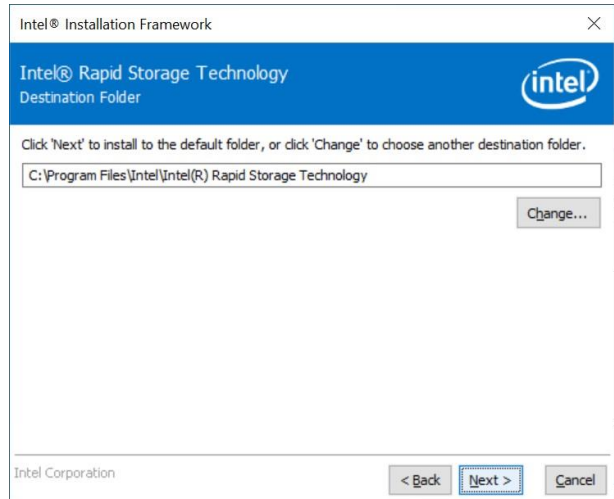

Step 4. Click Next.

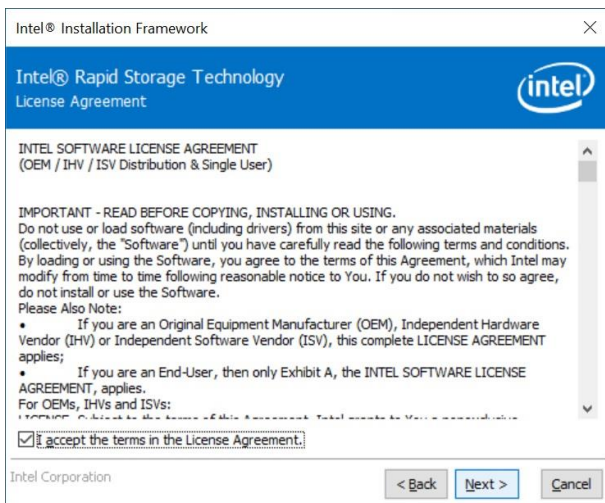

Step 2. Click Next.

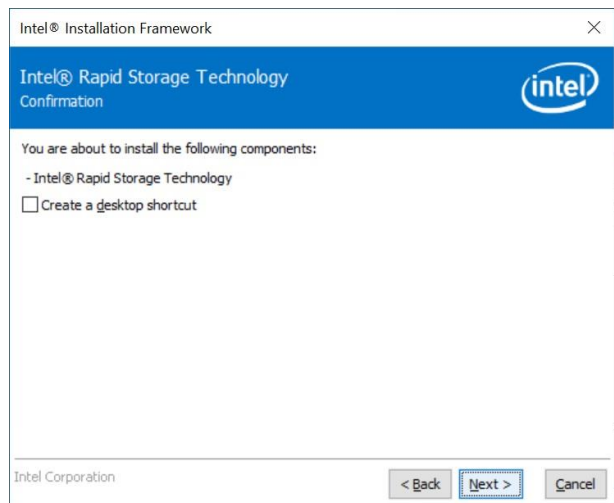

Step 5. Click Finish to complete setup.

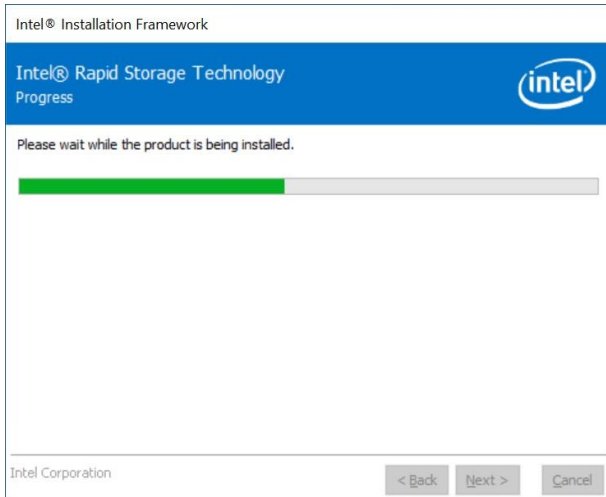

Step 6. Click Next.

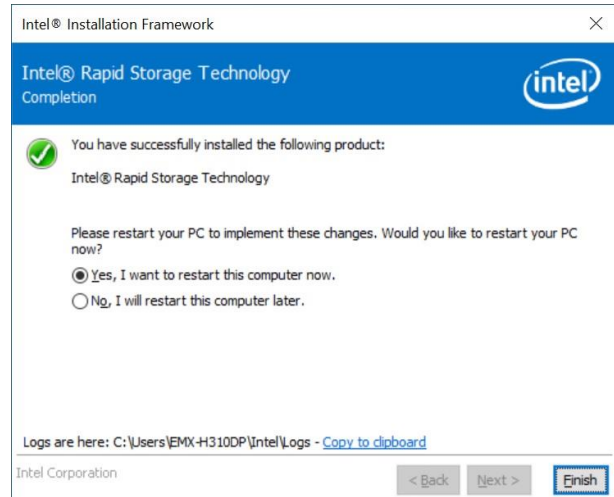

Step 7. Click Finish to complete setup.

5. Mechanical Drawing



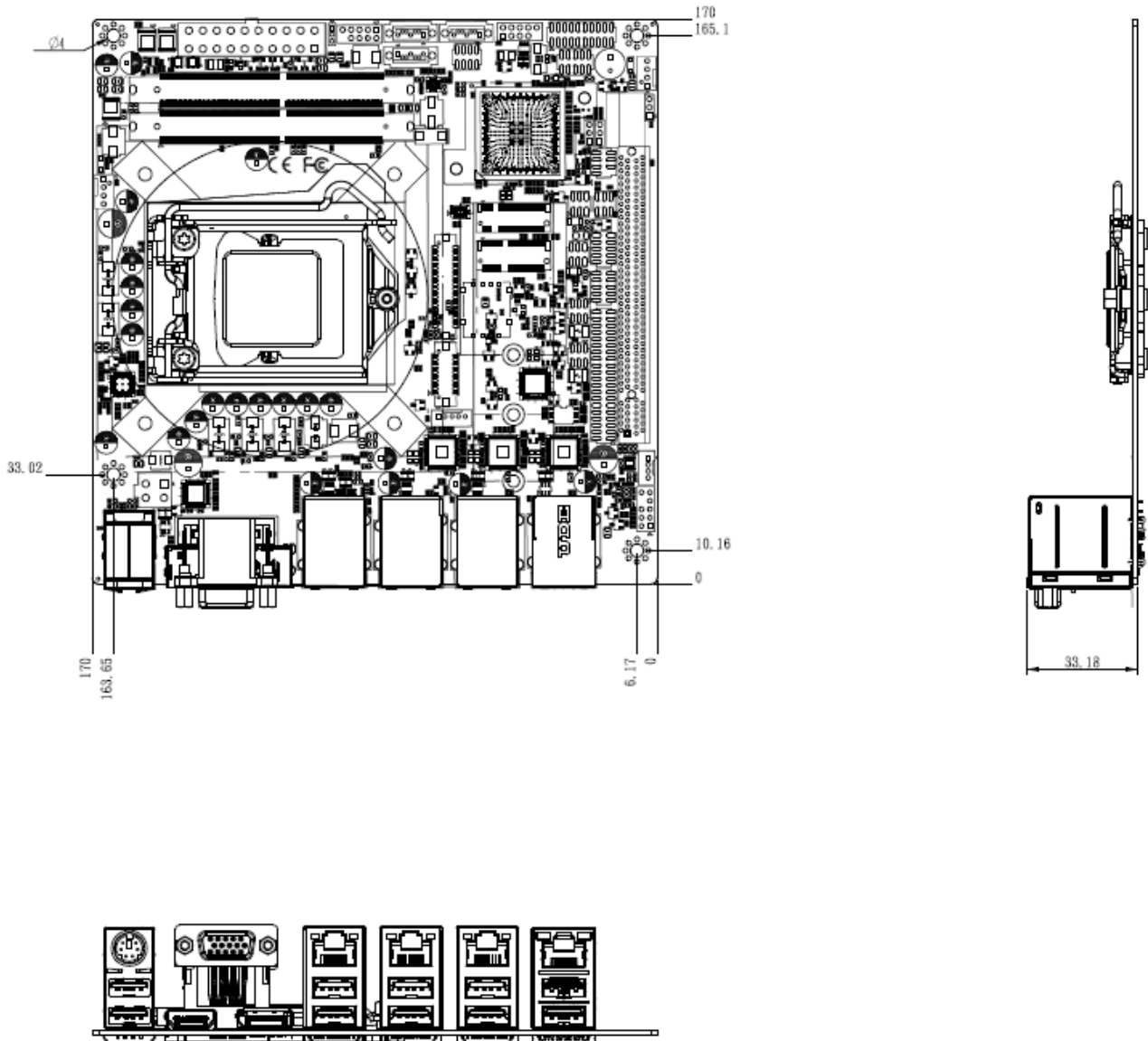

Unit: mm

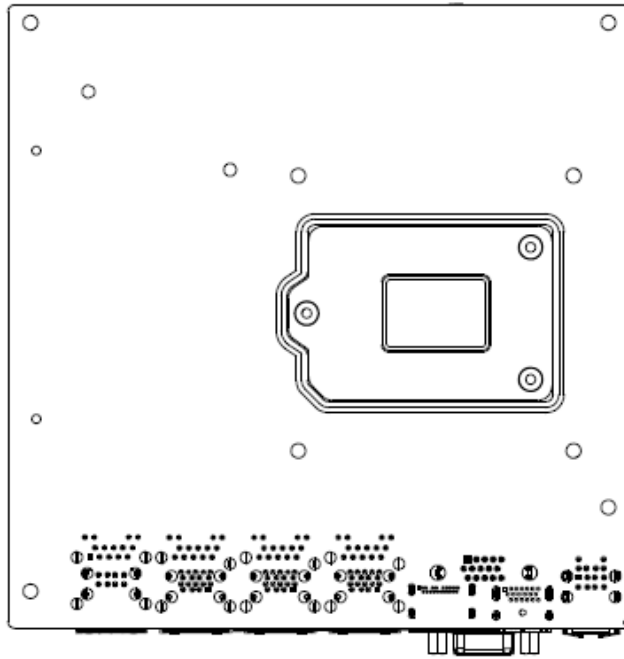

Unit: mm

